

8029
0,550 kg/m

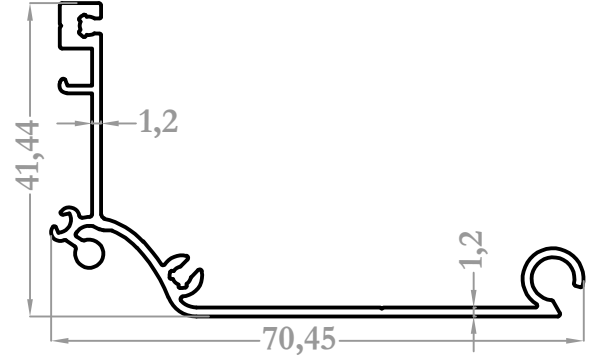

8030
0,525 kg/m

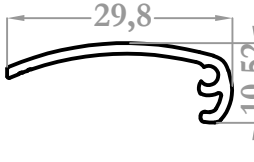

8075
0,157 kg/m

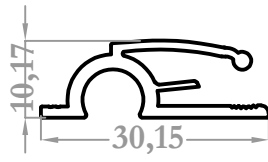

8076
0,267 kg/m

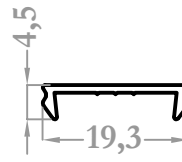

8084
0,074 kg/m

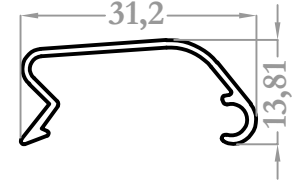

8088
0,164 kg/m

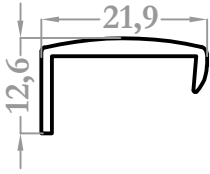

8090
0,171 kg/m

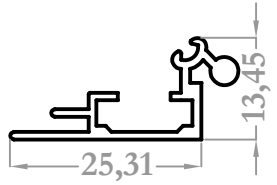

8198
0,210 kg/m

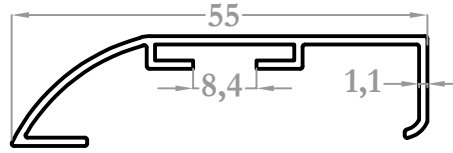

8204
0,294 kg/m

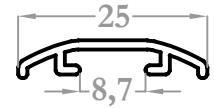

8202
0,121 kg/m

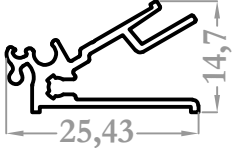

8240
0,223 kg/m

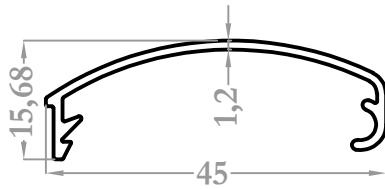

8241
0,235 kg/m

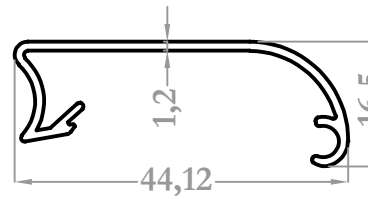

8242
0,266 kg/m

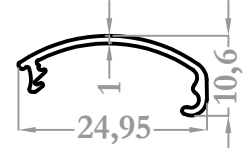

8243
0,107 kg/m

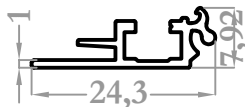

8244
0,138 kg/m

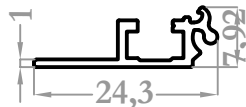

8245
0,127 kg/m

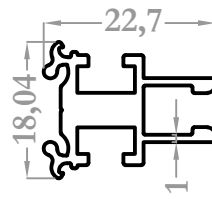

8307
0,338 kg/m

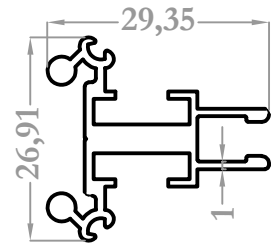

8308
0,448 kg/m

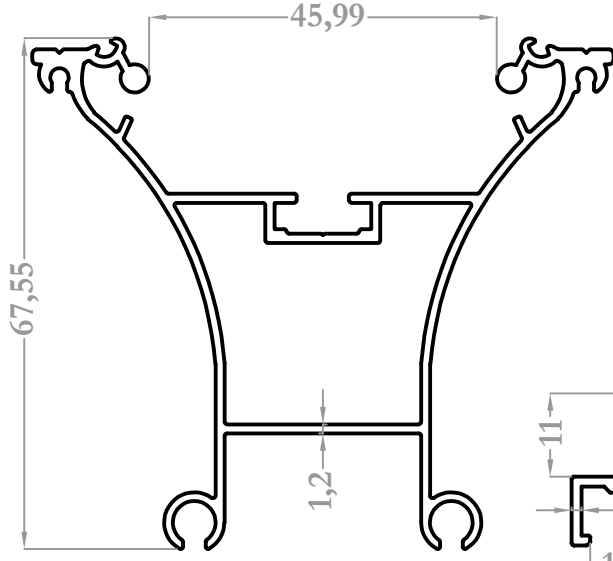

8119
1,072 kg/m

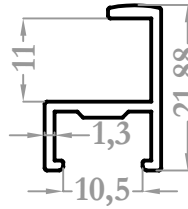

8200
0,200 kg/m

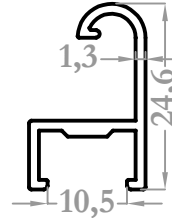

8201
0,216 kg/m

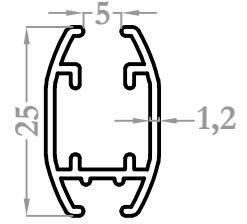

8203
0,267 kg/m

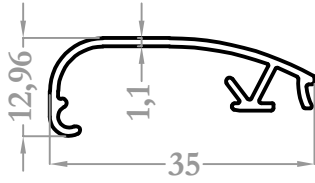

8434
0,197 kg/m

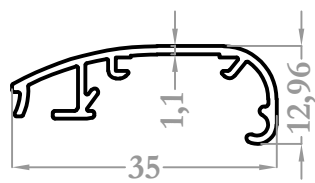

8435
0,215 kg/m

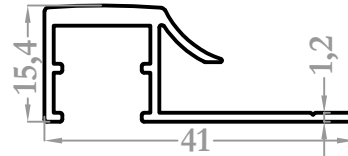

8369
0,321 kg/m

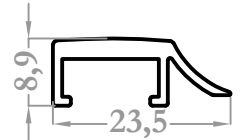

8370
0,188 kg/m

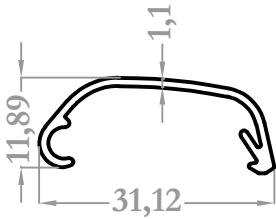

8397
0,165 kg/m

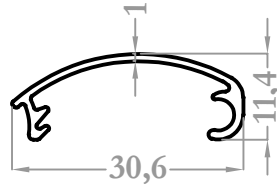

8428
0,151 kg/m

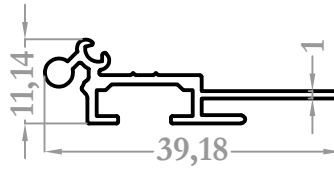

8429
0,234 kg/m

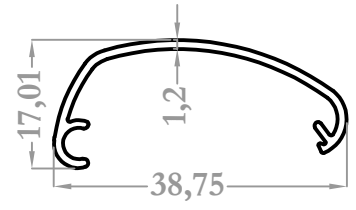

8430
0,210 kg/m

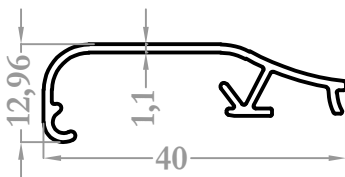

8432
0,215 kg/m

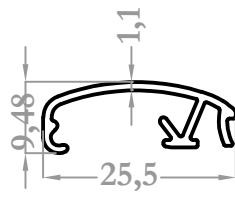

8433
0,153 kg/m

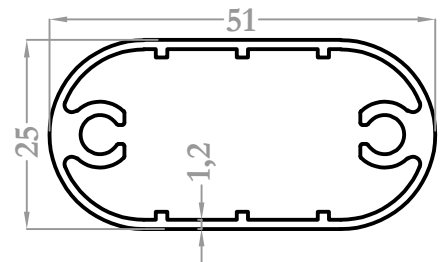

8371
0,664 kg/m

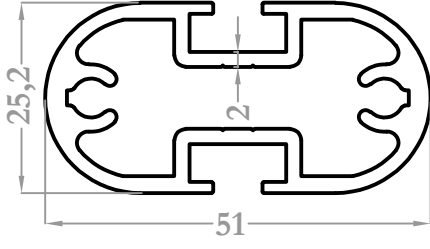

8485
1,084 kg/m

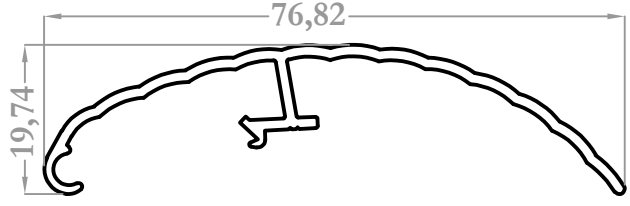

8488
0,458 kg/m

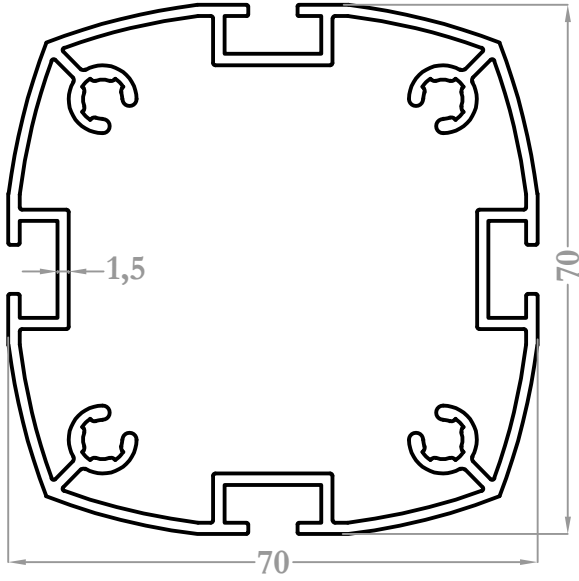

8486
1,704 kg/m

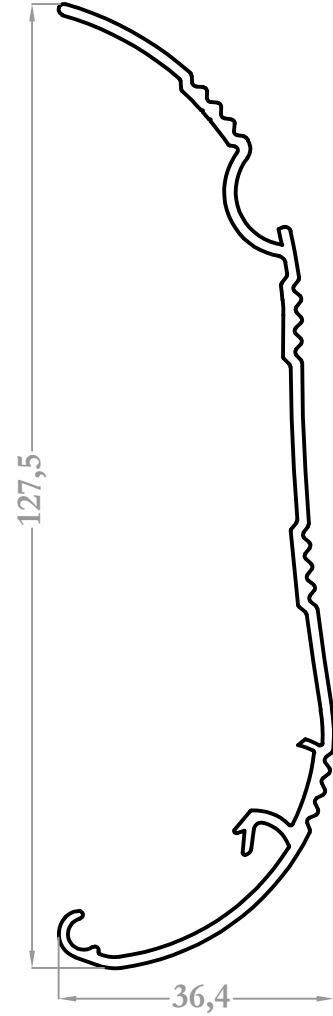

8489
0,818 kg/m

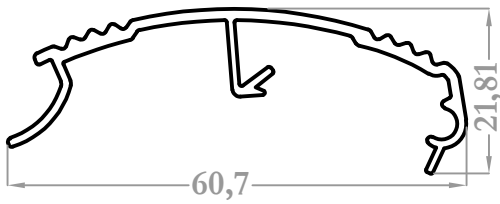

8487
0,425 kg/m

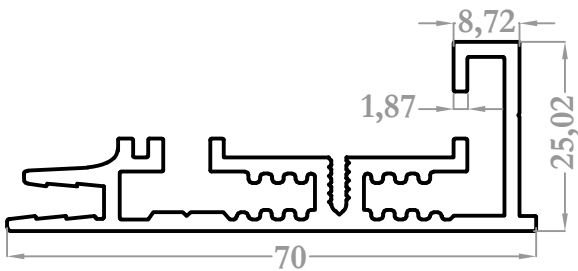

9212
1,029 kg/m

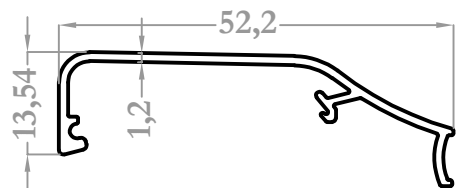

8500
0,275 kg/m

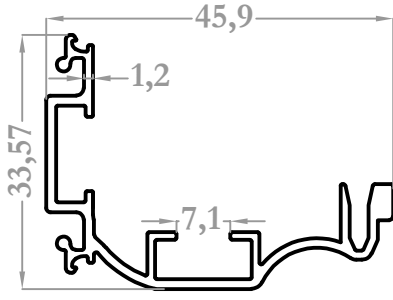

8501
0,447 kg/m

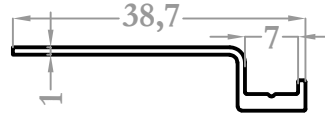

8503
0,153 kg/m

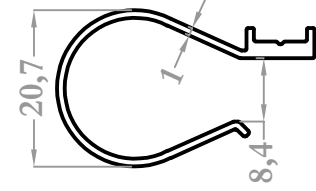

8504
0,234 kg/m

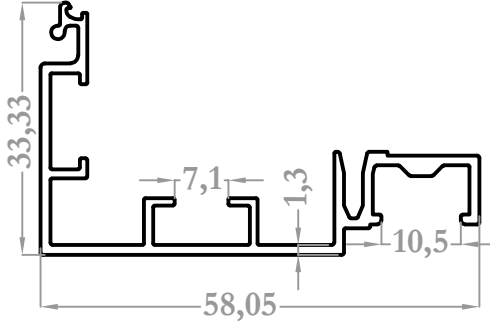

8502
0,550 kg/m

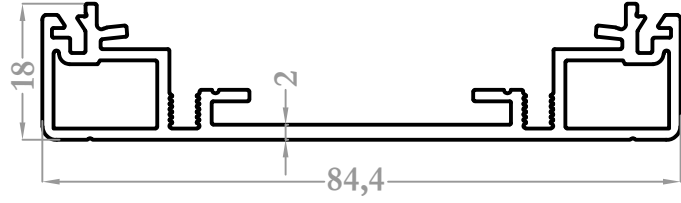

8505
0,926 kg/m

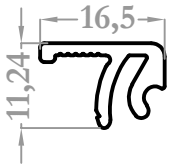

8507
0,181 kg/m

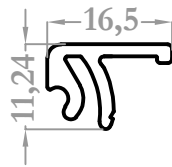

8508
0,182 kg/m

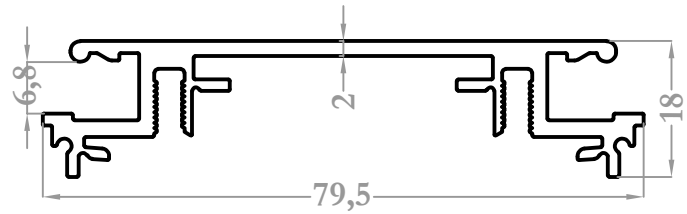

8506
0,902 kg/m

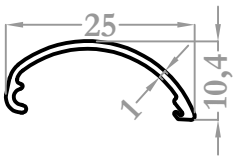

8575
0,102 kg/m

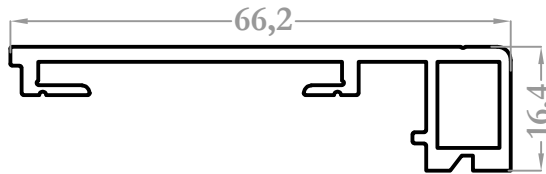

8784
0,627 kg/m

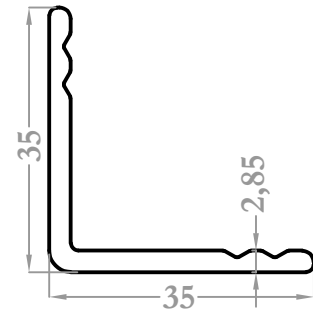

8817
0,492 kg/m

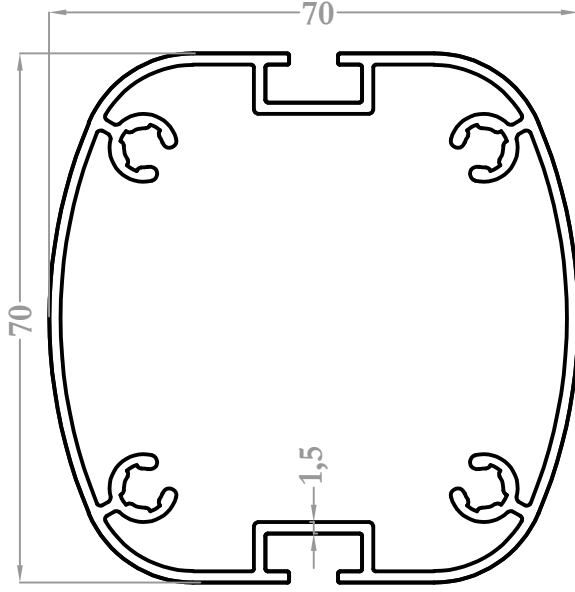

8523
1,491 kg/m

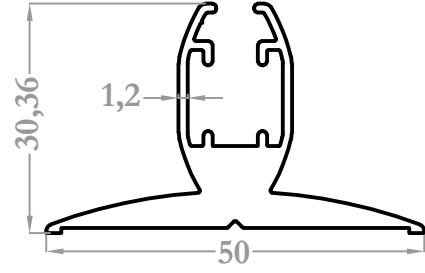

8849
0,712 kg/m

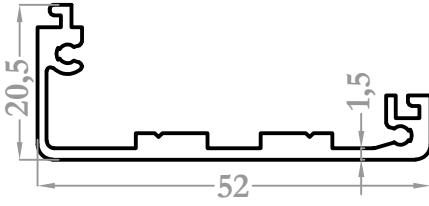

8891
0,506 kg/m

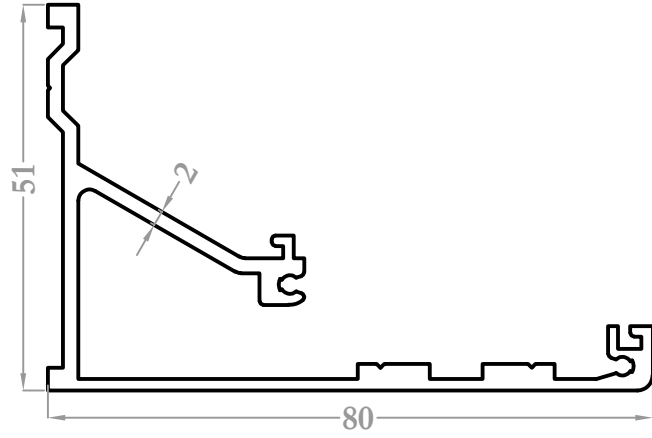

8892
1,046 kg/m

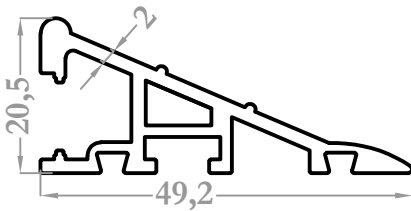

8032
0,577 kg/m

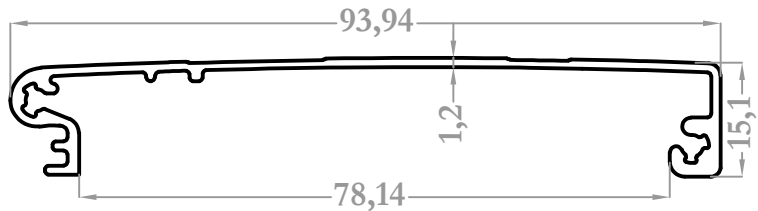

8081
0,520 kg/m

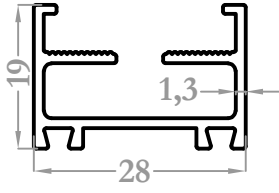

8031
0,336 kg/m

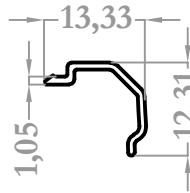

8087
0,062 kg/m

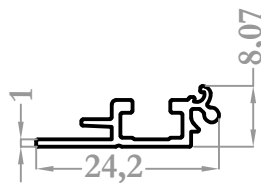

8097
0,138 kg/m

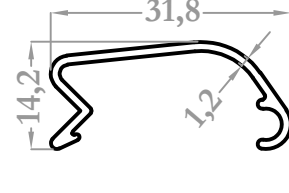

8098
0,190 kg/m

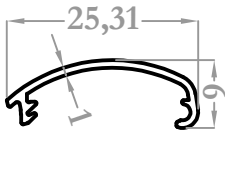

8099
0,104 kg/m

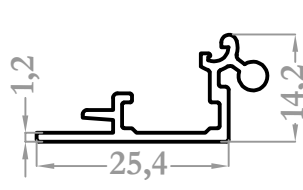

8100
0,221 kg/m

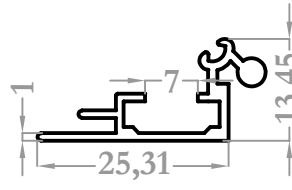

8198
0,210 kg/m

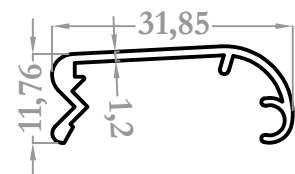

8321
0,210 kg/m

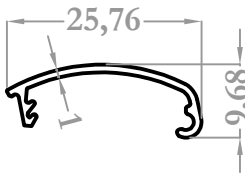

8322
0,108 kg/m

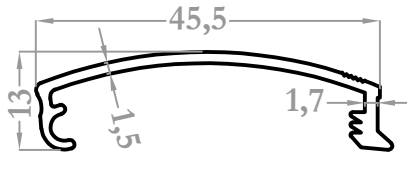

8360
0,286 kg/m

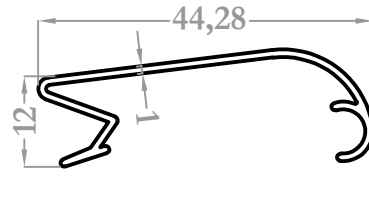

8361
0,224 kg/m

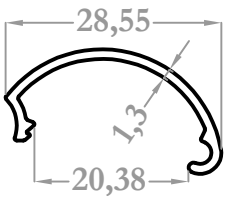

8326
0,171 kg/m

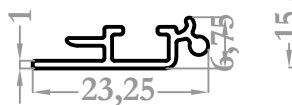

8363
0,121 kg/m

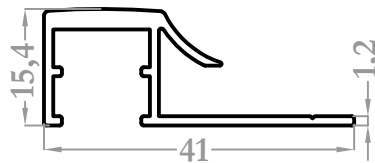

8369
0,321 kg/m

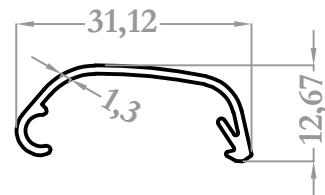

8397
0,165 kg/m

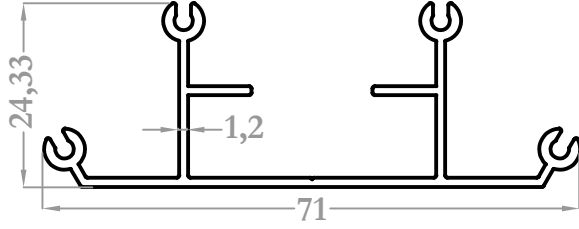

8029
0,550 kg/m

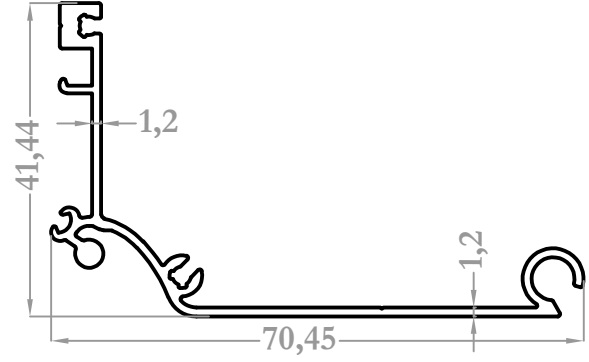

8030
0,525 kg/m

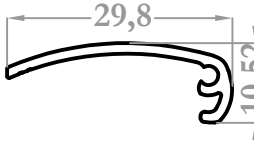

8075
0,157 kg/m

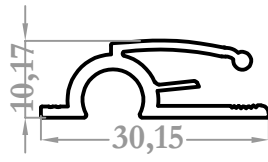

8076
0,267 kg/m

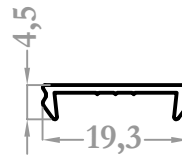

8084
0,074 kg/m

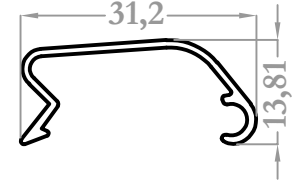

8088
0,164 kg/m

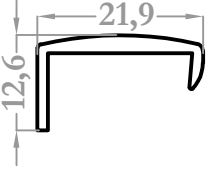

8090
0,171 kg/m

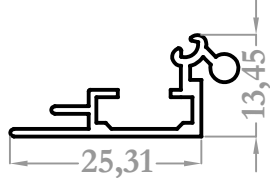

8198
0,210 kg/m

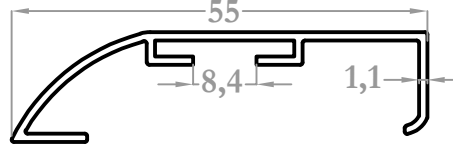

8204
0,294 kg/m

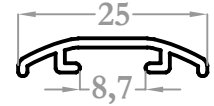

8202
0,121 kg/m

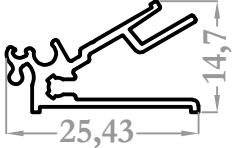

8240
0,223 kg/m

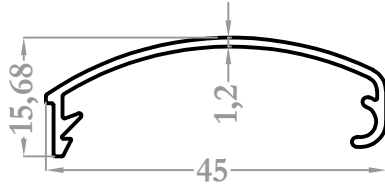

8241
0,235 kg/m

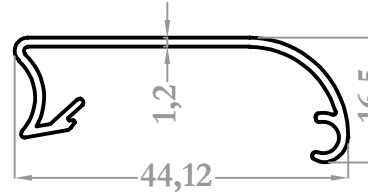

8242
0,266 kg/m

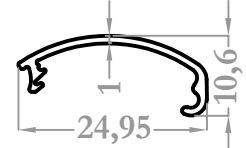

8243
0,107 kg/m

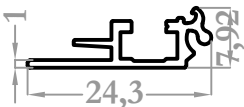

8244
0,138 kg/m

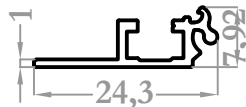

8245
0,127 kg/m

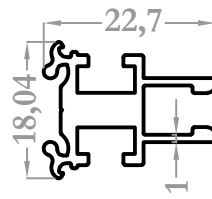

8307
0,338 kg/m

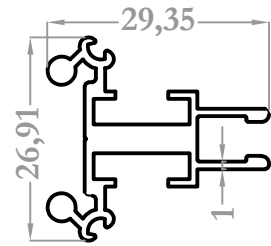

8308
0,448 kg/m

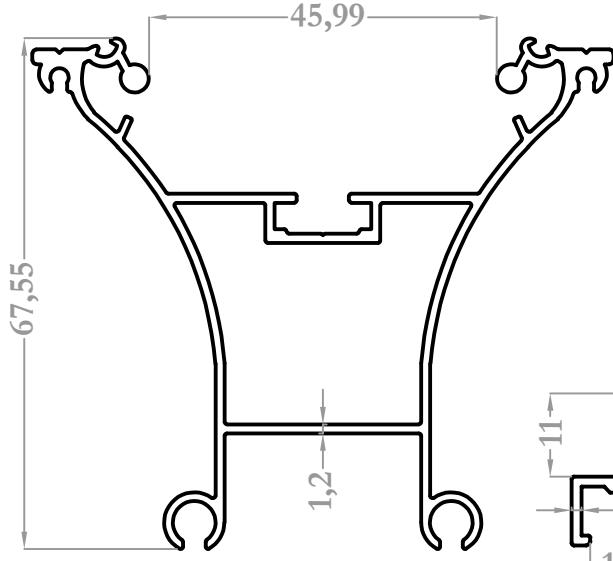

8119
1,072 kg/m

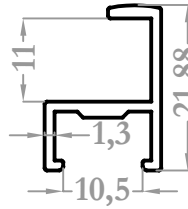

8200
0,200 kg/m

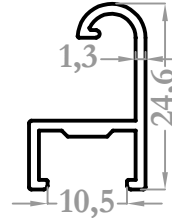

8201
0,216 kg/m

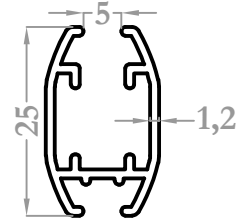

8203
0,267 kg/m

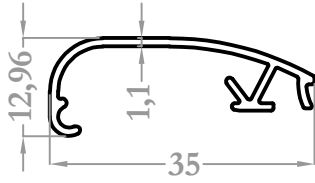

8434
0,197 kg/m

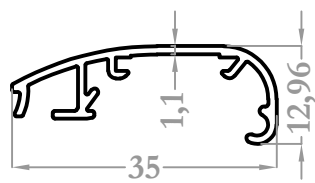

8435
0,215 kg/m

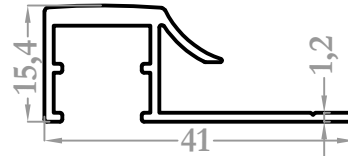

8369
0,321 kg/m

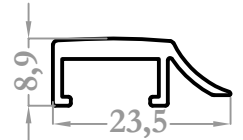

8370
0,188 kg/m

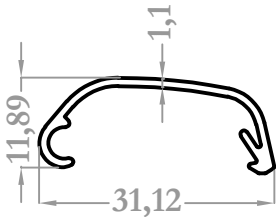

8397
0,165 kg/m

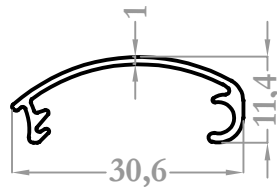

8428
0,151 kg/m

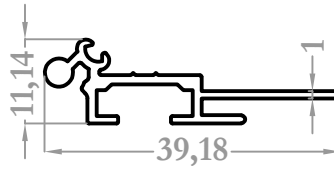

8429
0,234 kg/m

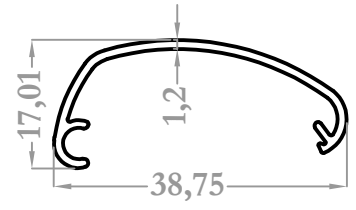

8430
0,210 kg/m

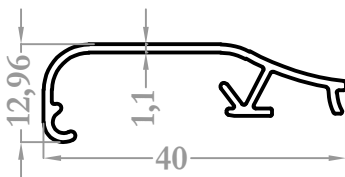

8432
0,215 kg/m

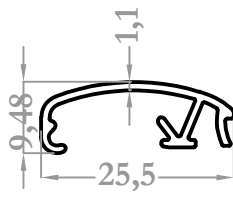

8433
0,153 kg/m

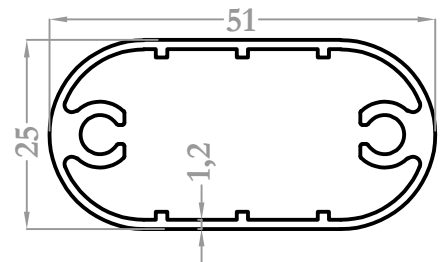

8371
0,664 kg/m

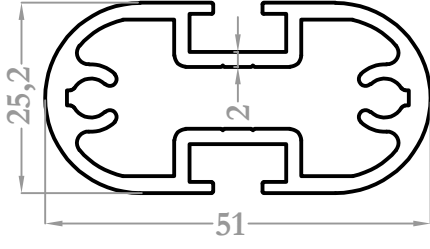

8485
1,084 kg/m

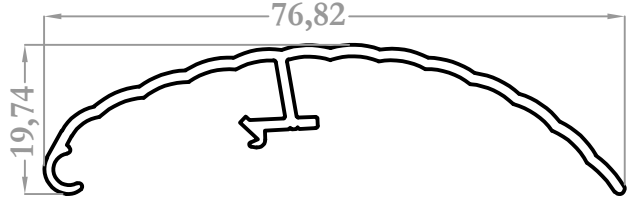

8488
0,458 kg/m

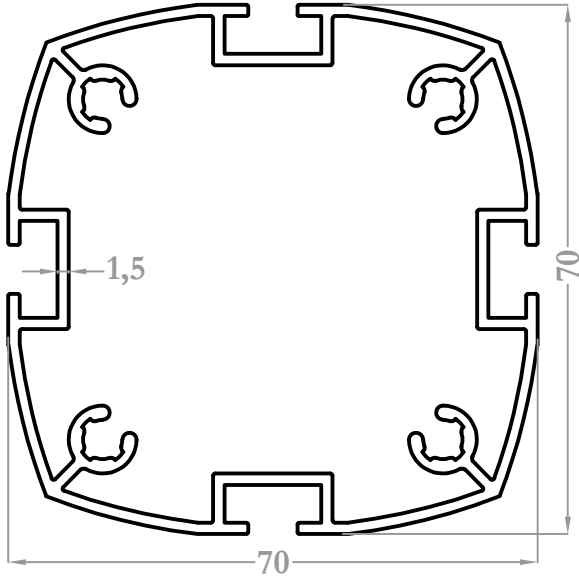

8486
1,704 kg/m

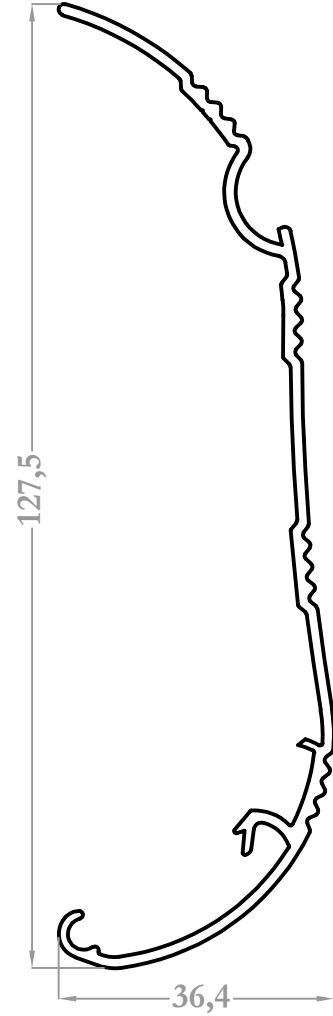

8489
0,818 kg/m

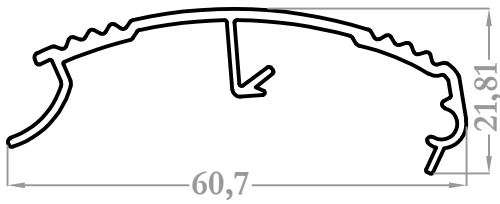

8487
0,425 kg/m

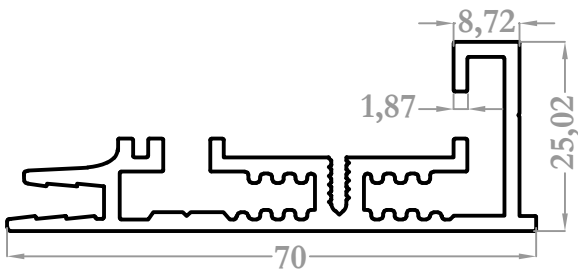

9212
1,029 kg/m

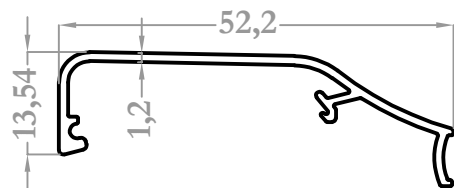

8500
0,275 kg/m

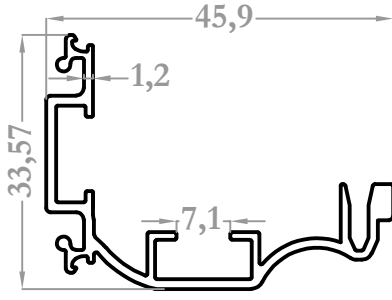

8501
0,447 kg/m

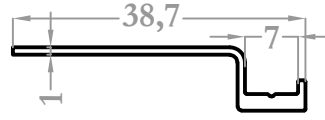

8503
0,153 kg/m

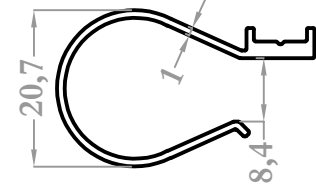

8504
0,234 kg/m

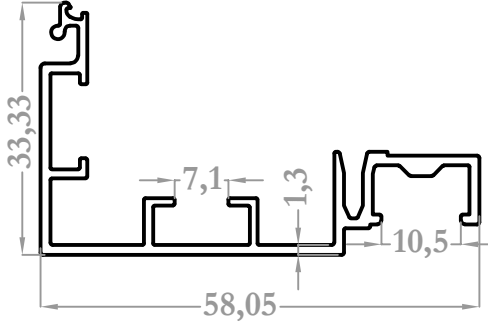

8502
0,550 kg/m

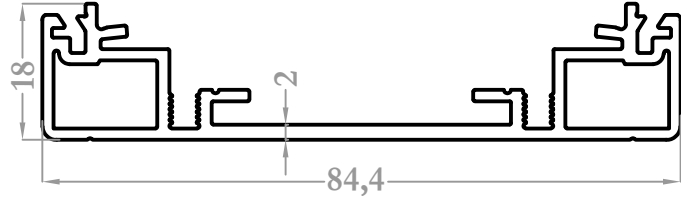

8505
0,926 kg/m

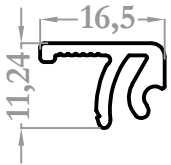

8507
0,181 kg/m

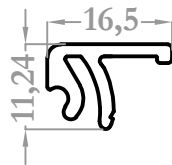

8508
0,182 kg/m

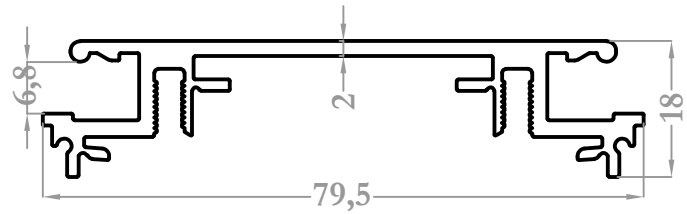

8506
0,902 kg/m

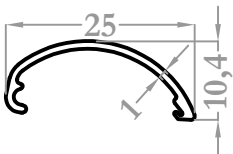

8575
0,102 kg/m

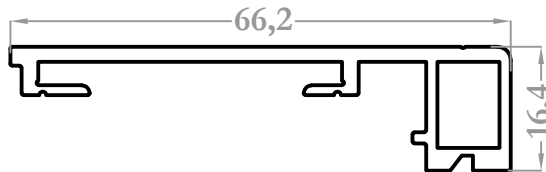

8784
0,627 kg/m

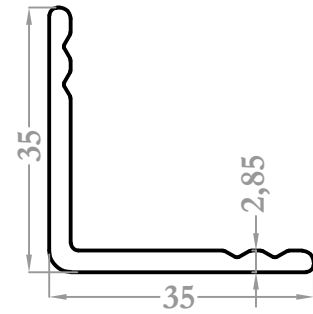

8817
0,492 kg/m

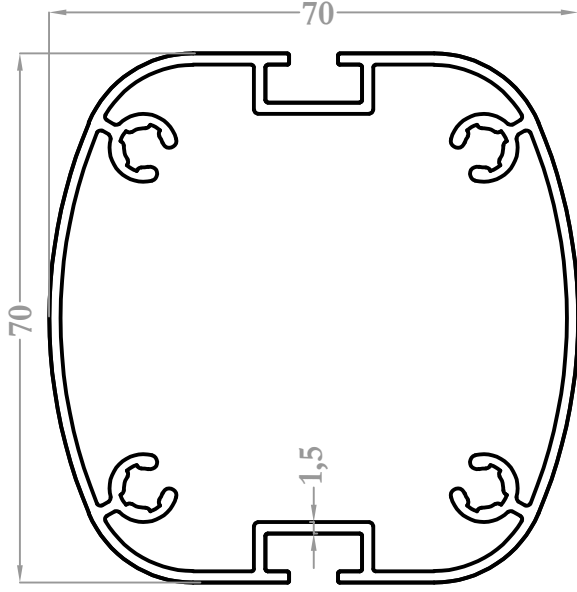

8523
1,491 kg/m

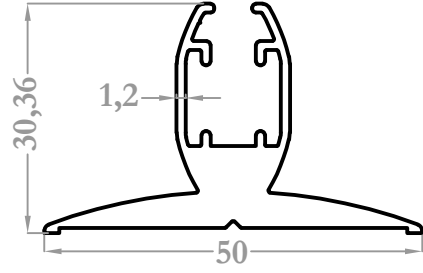

8849
0,712 kg/m

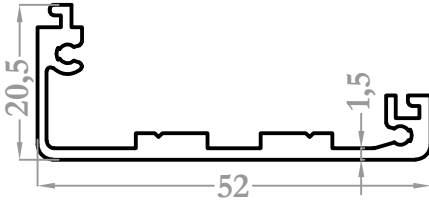

8891
0,506 kg/m

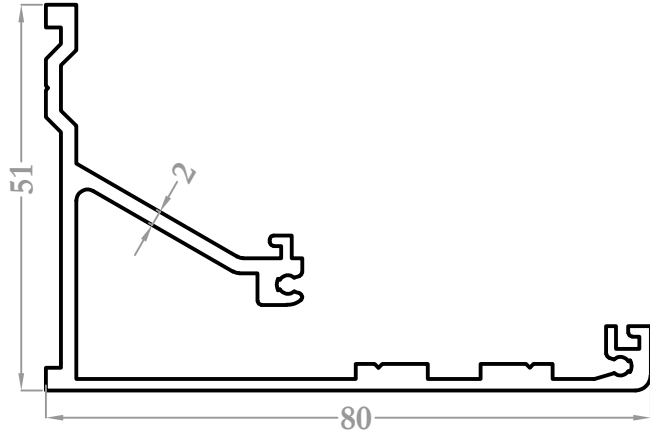

8892
1,046 kg/m

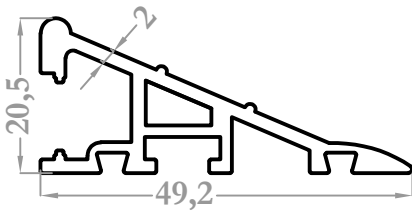

8032
0,577 kg/m

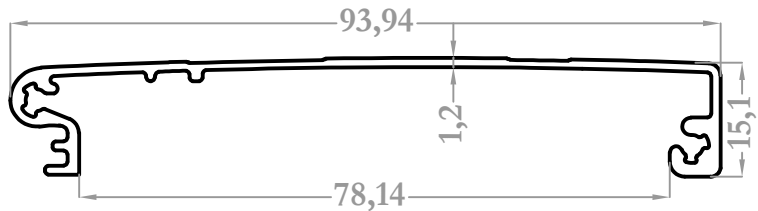

8081
0,520 kg/m

8326
0,171 kg/m

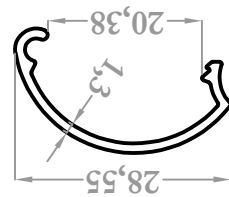

8363
0,121 kg/m

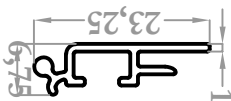

8369
0,321 kg/m

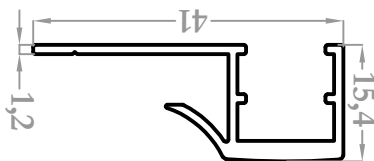

8397
0,165 kg/m

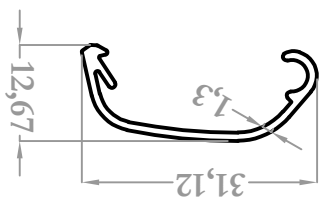

8322
0,108 kg/m

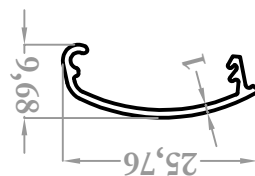

8360
0,286 kg/m



8361
0,224 kg/m

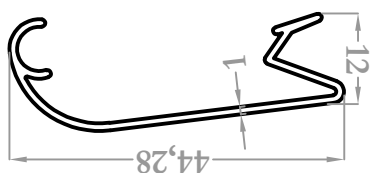

8099
0,104 kg/m

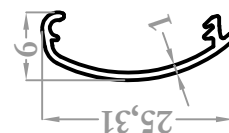

8100
0,221 kg/m

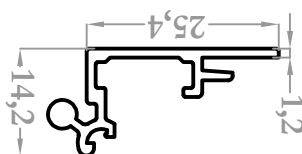

8198
0,210 kg/m

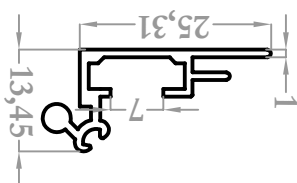

8321
0,210 kg/m

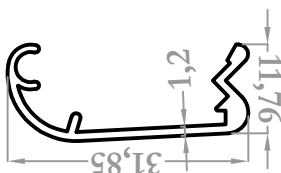

8031
0,336 kg/m

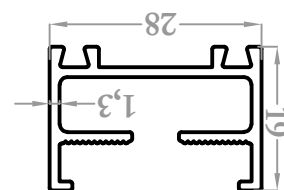

8087
0,062 kg/m

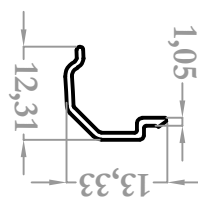

8097
0,138 kg/m

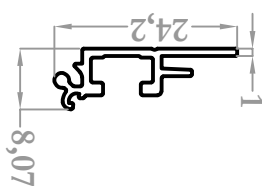

8098
0,190 kg/m

