

9509
0,503 kg/m

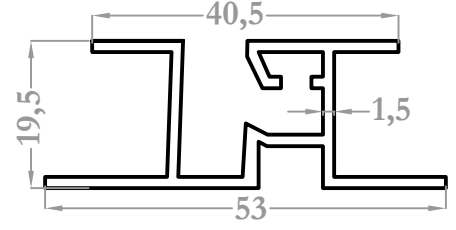

9564
0,546 kg/m

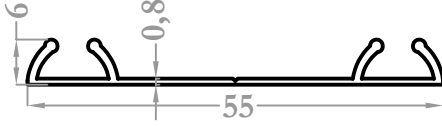

9479
0,201 kg/m

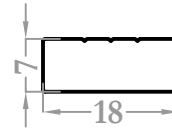

9482
0,340 kg/m

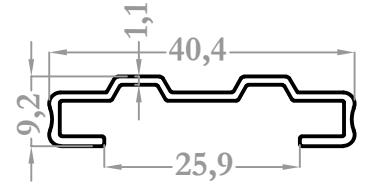

9480
0,211 kg/m

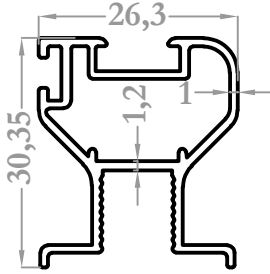

9358
0,408 kg/m

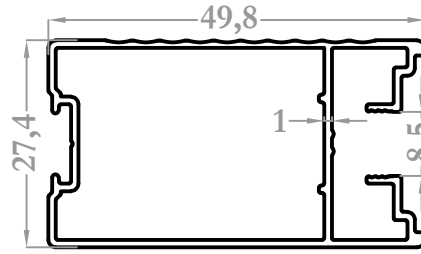

9361
0,491 kg/m

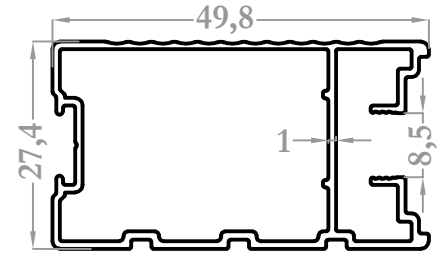

9362
0,510 kg/m

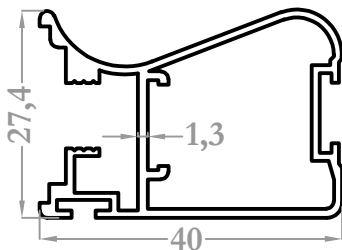

9364
0,521 kg/m

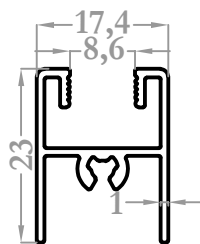

9363
0,253 kg/m

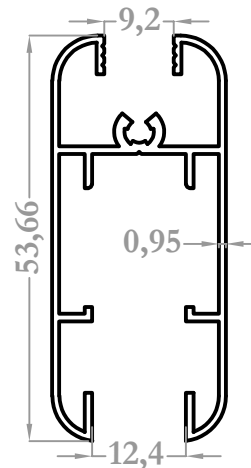

9365
0,503 kg/m

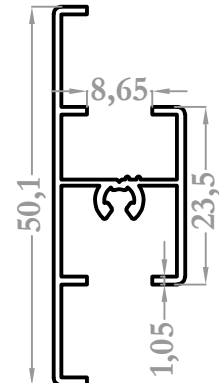

9366
0,337 kg/m

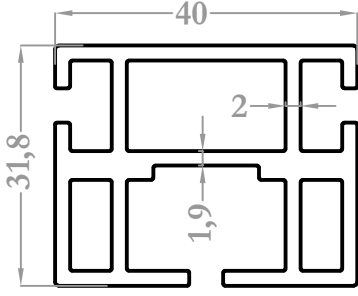

9367
1,220 kg/m

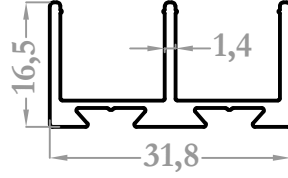

9394
0,347 kg/m

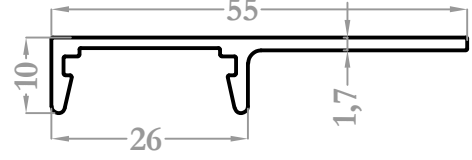

9596
0,335 kg/m

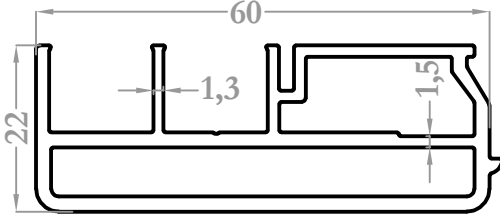

9395
1,038 kg/m

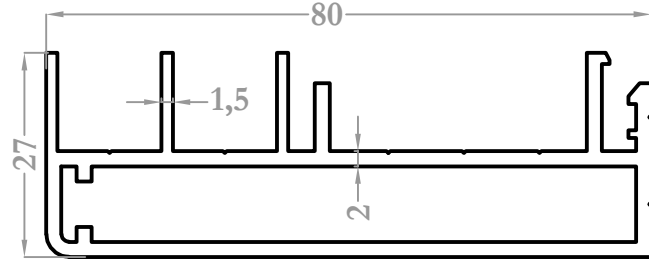

9401
1,328 kg/m

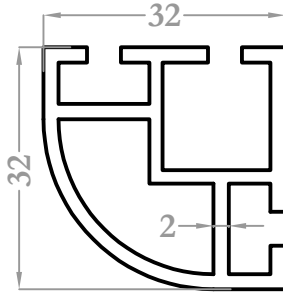

9402
0,801 kg/m

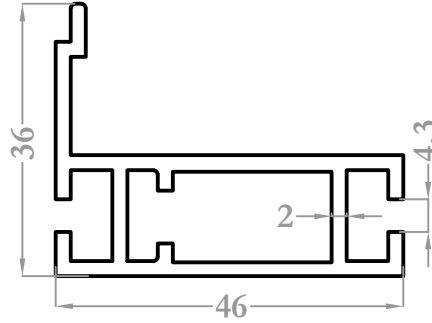

9403
0,859 kg/m

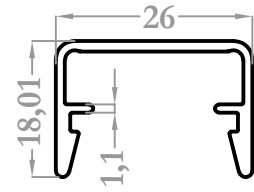

9595
0,246 kg/m

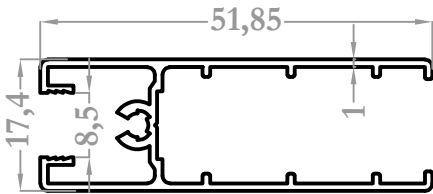

9417
0,423 kg/m

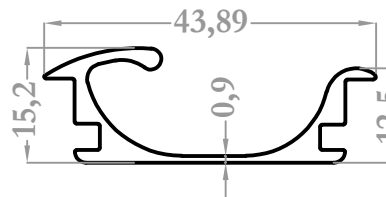

9423
0,379 kg/m

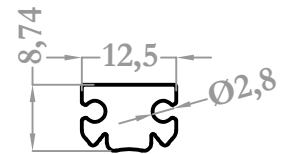

9597
0,230 kg/m

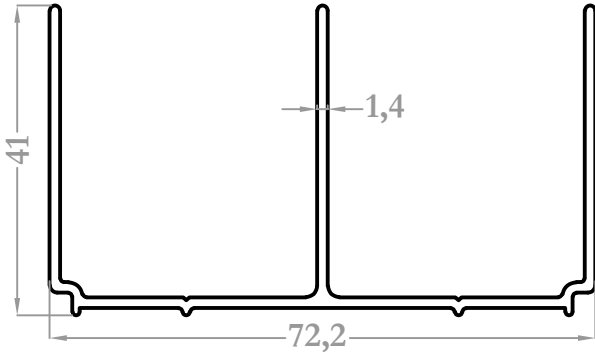

2100
0,718 kg/m

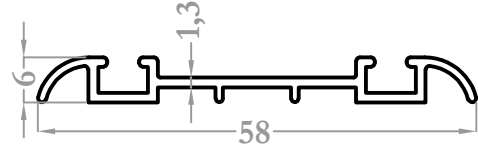

2101
0,303 kg/m

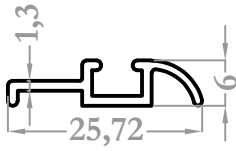

2102
0,141 kg/m

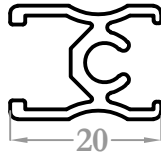

2103
0,253 kg/m

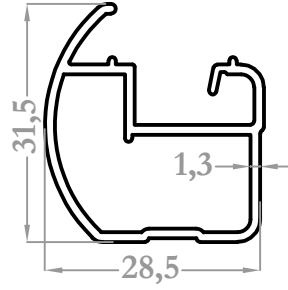

2104
0,421 kg/m

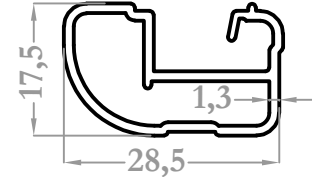

2105
0,336 kg/m

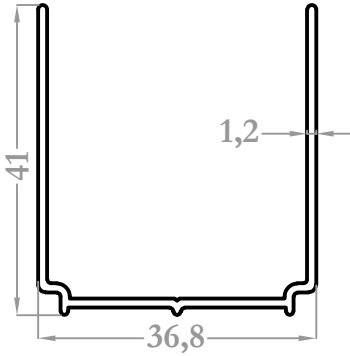

2106
0,317 kg/m

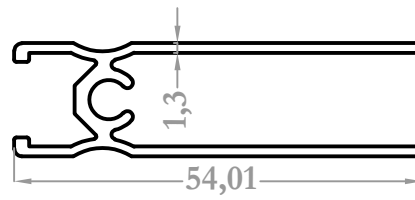

2107
0,489 kg/m

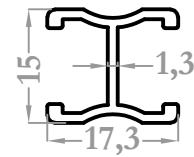

2108
0,182 kg/m

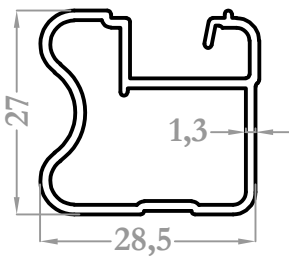

2109
0,424 kg/m

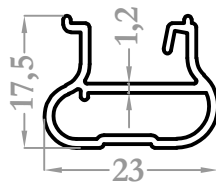

2110
0,256 kg/m

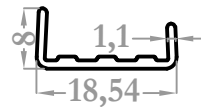

2114
0,097 kg/m

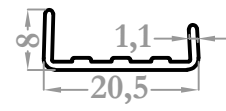

2115
0,103 kg/m

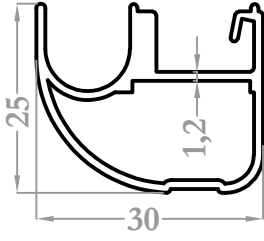

2111
0,420 kg/m

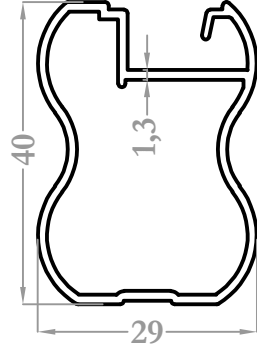

2112
0,482 kg/m

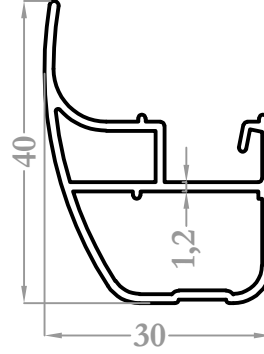

2113
0,449 kg/m

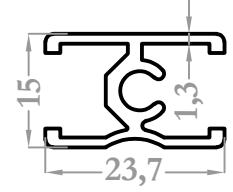

2116
0,295 kg/m

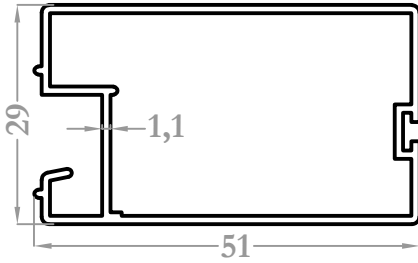

2118
0,536 kg/m

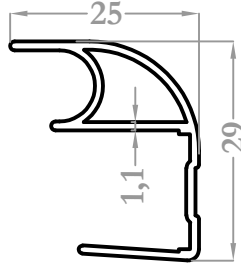

2117
0,284 kg/m

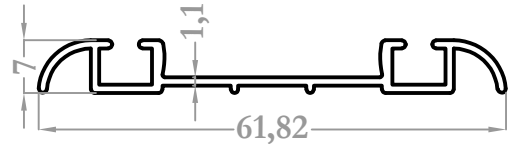

2120
0,309 kg/m

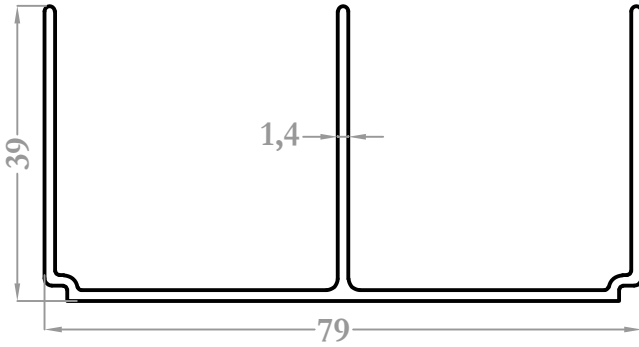

2119
0,723 kg/m

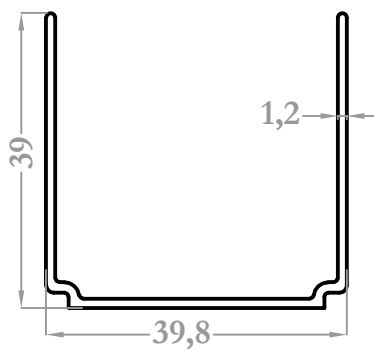

2121
0,373 kg/m

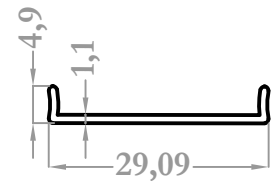

2122
0,108 kg/m

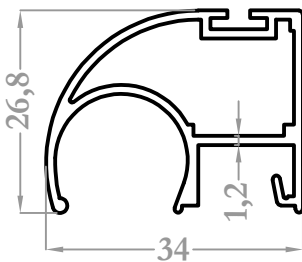

2123
0,463 kg/m

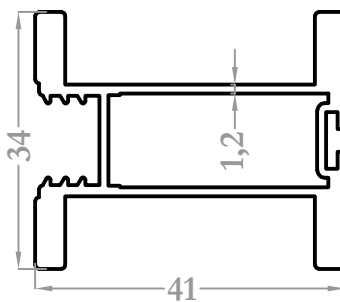

2124
0,813 kg/m

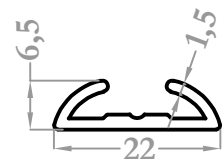

2125
0,159 kg/m

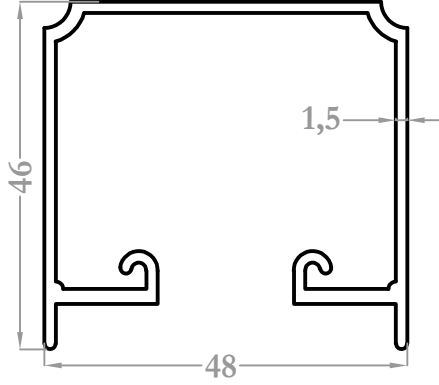

2126
0,772 kg/m

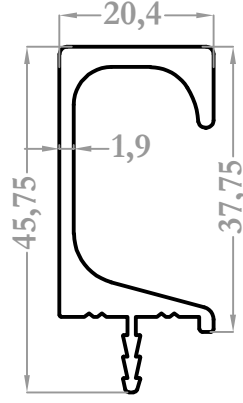

8052
0,637 kg/m

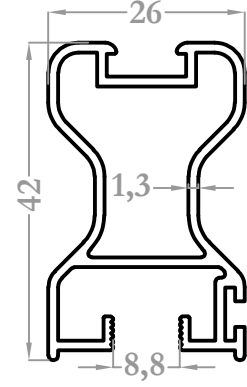

8092
0,597 kg/m

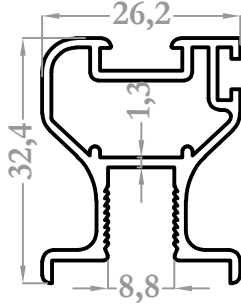

8093
0,496 kg/m

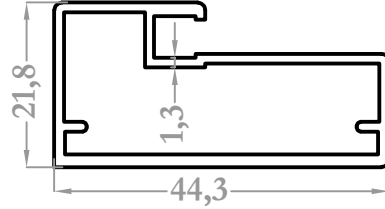

8091
0,550 kg/m

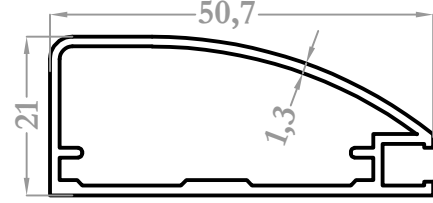

8094
0,520 kg/m

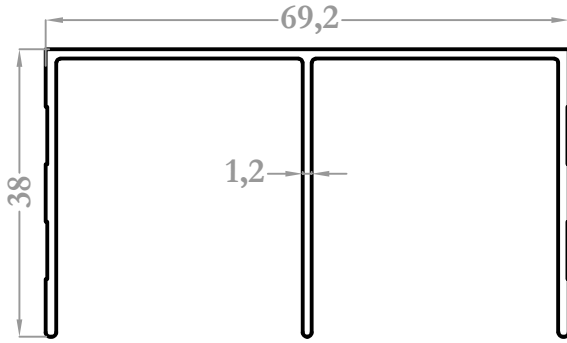

8096
0,605 kg/m

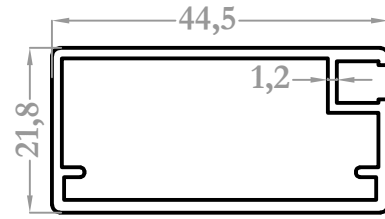

8103
0,561 kg/m

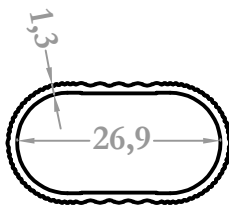

8108
0,236 kg/m

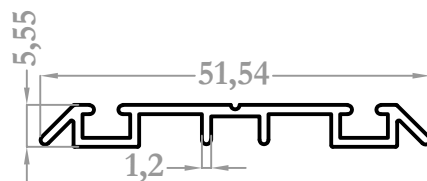

8127
0,281 kg/m

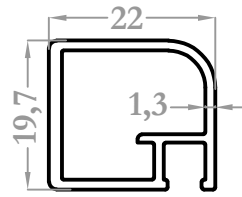

8114
0,312 kg/m

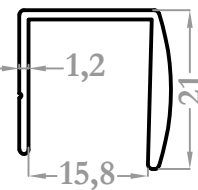

8136
0,240 kg/m

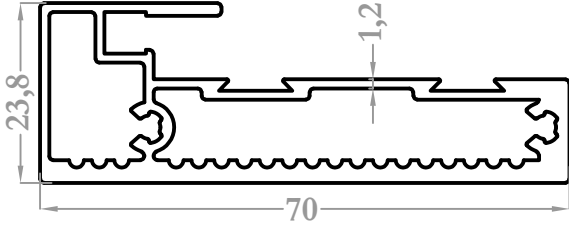

8137
1,094 kg/m

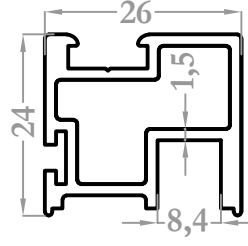

8138
0,521 kg/m

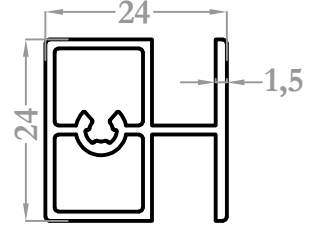

8139
0,427 kg/m

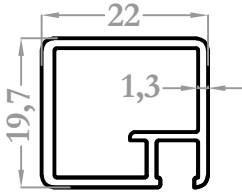

8140
0,317 kg/m

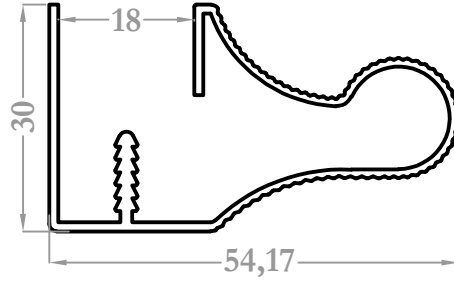

8145
0,510 kg/m

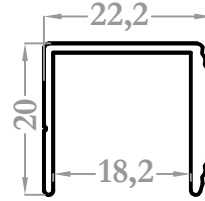

8148
0,242 kg/m

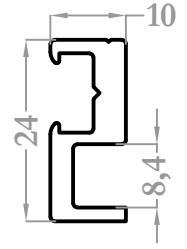

8680
0,333 kg/m

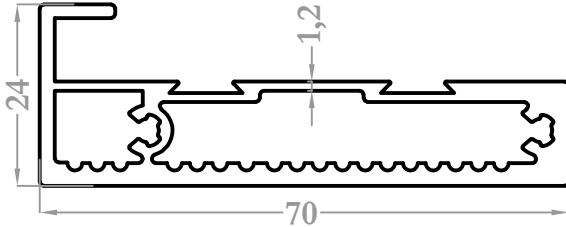

8150
1,124 kg/m

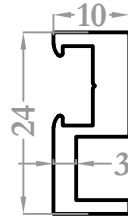

8151
0,350 kg/m

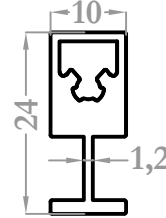

8152
0,333 kg/m

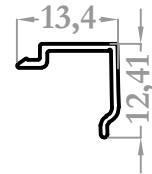

8158
0,069 kg/m

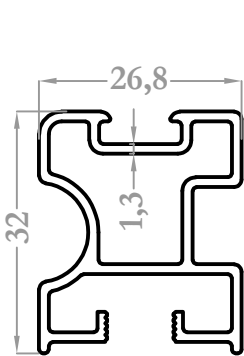

8153
0,536 kg/m

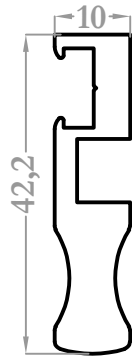

8154
0,737 kg/m

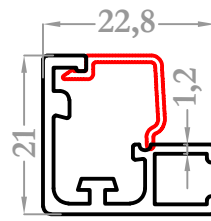

8156
0,296 kg/m

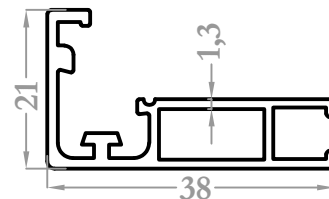

8157
0,419 kg/m

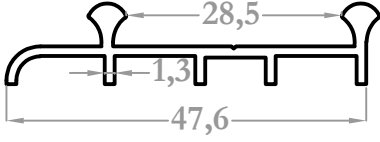

8163
0,318 kg/m

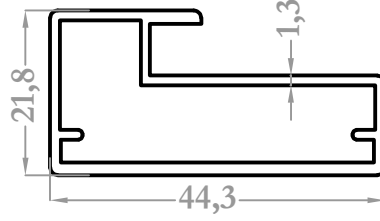

8164
0,544 kg/m

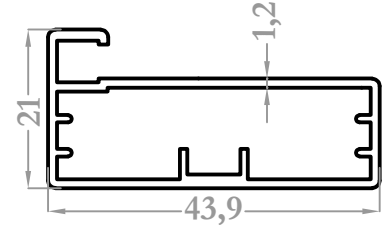

8169
0,470 kg/m

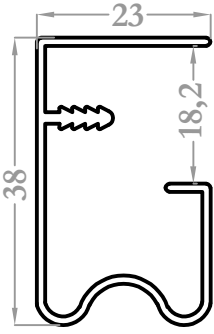

8167
0,369 kg/m

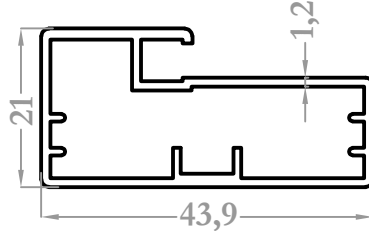

8170
0,501 kg/m

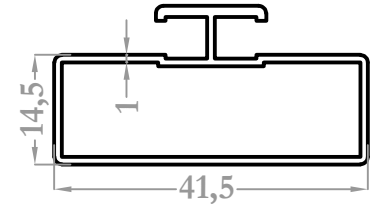

8171
0,370 kg/m

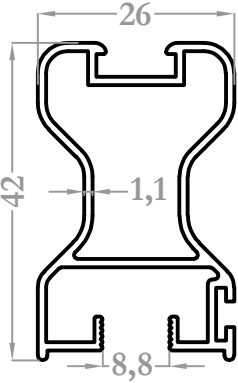

8172
0,513 kg/m

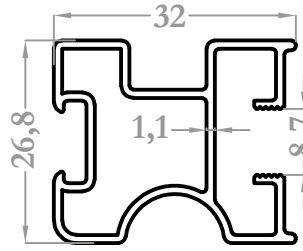

8173
0,453 kg/m

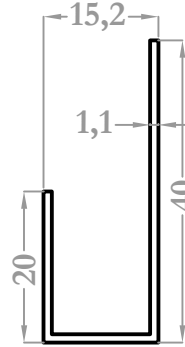

8179
0,217 kg/m

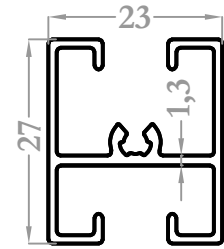

8181
0,376 kg/m

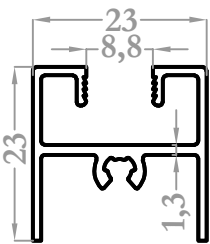

8182
0,312 kg/m

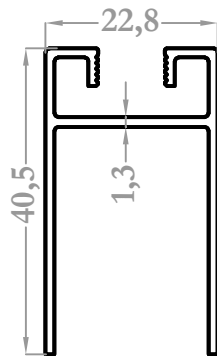

8184
0,397 kg/m

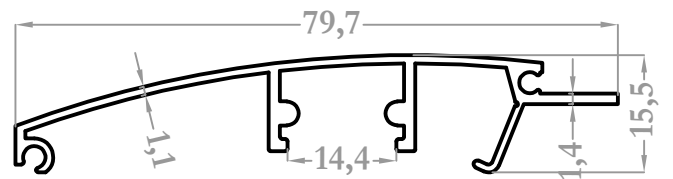

8065
0,481 kg/m

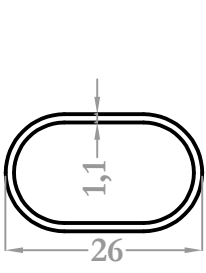

8185
0,197 kg/m

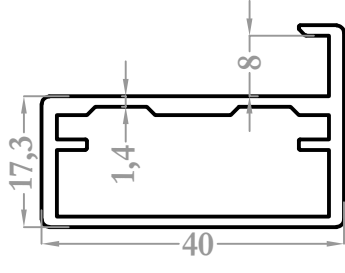

8199
0,615 kg/m

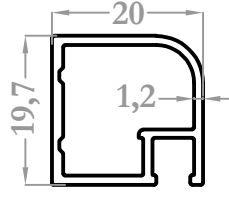

8194
0,266 kg/m

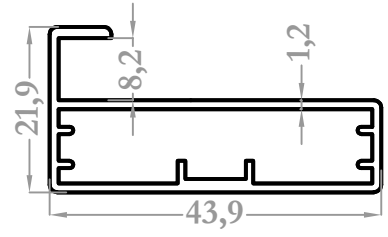

8224
0,457 kg/m

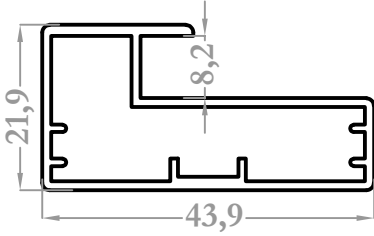

8225
0,497 kg/m

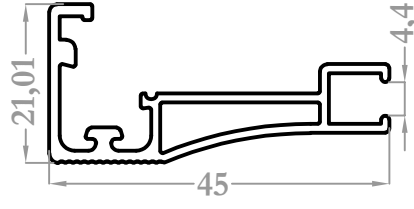

8226
0,459 kg/m

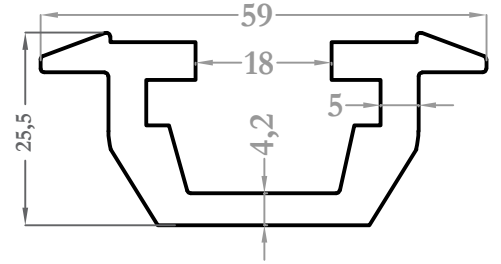

8049
1,325 kg/m

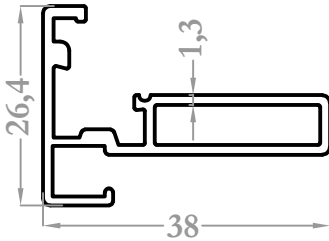

8228
0,435 kg/m

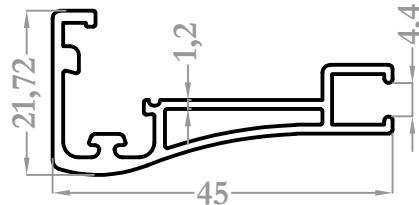

8229
0,474 kg/m

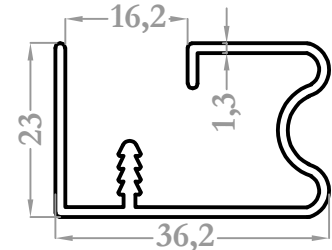

8230
0,417 kg/m

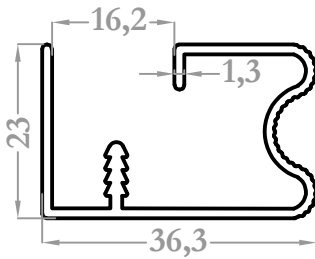

8231
0,417 kg/m

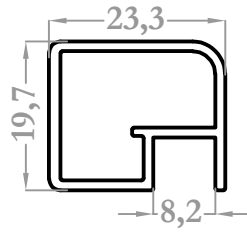

8233
0,315 kg/m

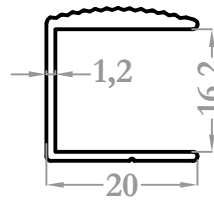

8234
0,235 kg/m

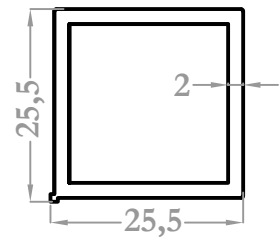

8236
0,500 kg/m

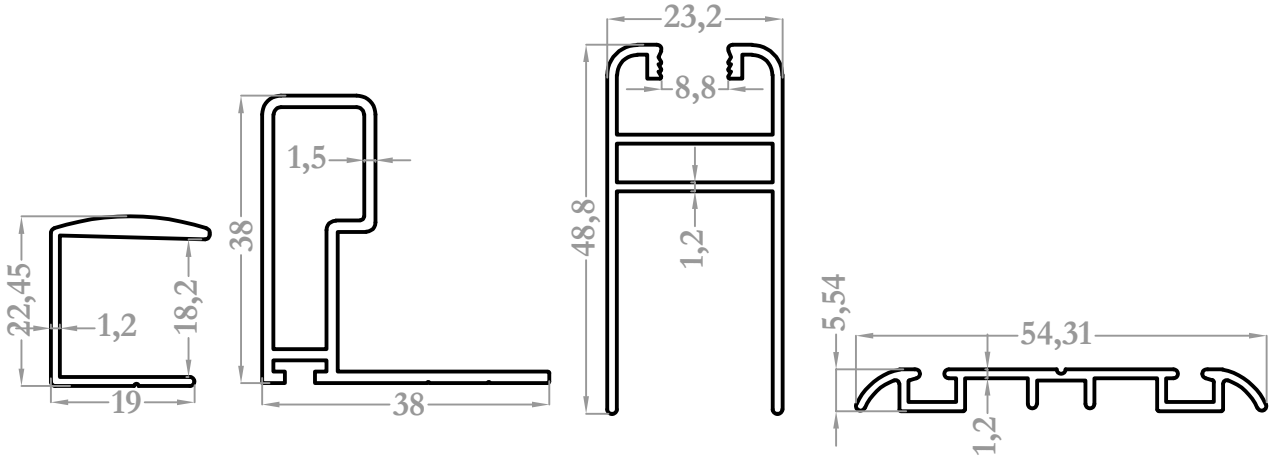

8257
0,248 kg/m

8266
0,525 kg/m

8278
0,535 kg/m

8279
0,275 kg/m

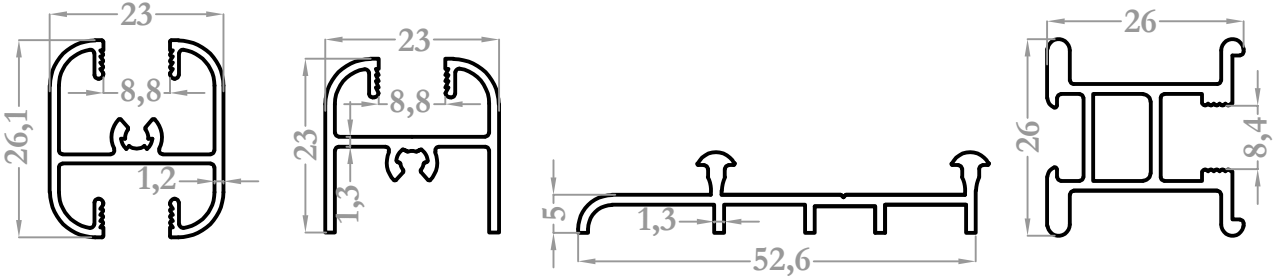

8280
0,378 kg/m

8281
0,323 kg/m

8282
0,324 kg/m

8283
0,450 kg/m

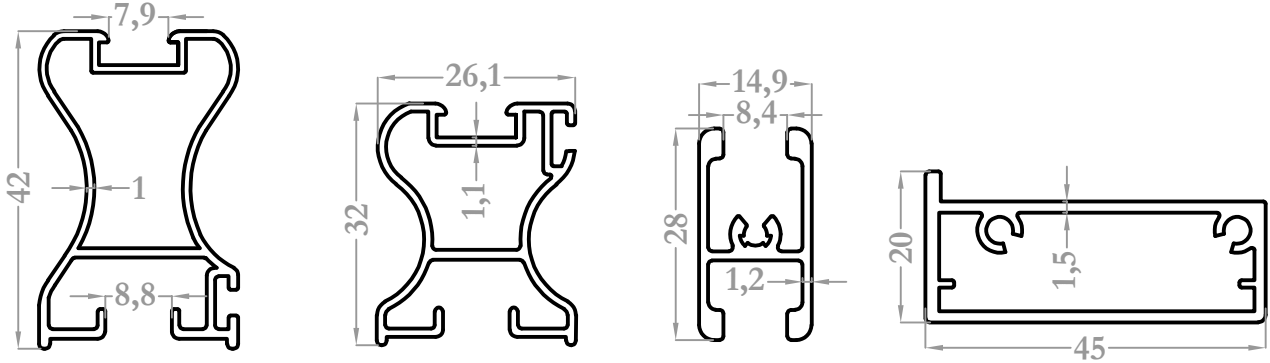

8284
0,463 kg/m

8285
0,438 kg/m

8290
0,350 kg/m

8299
0,576 kg/m

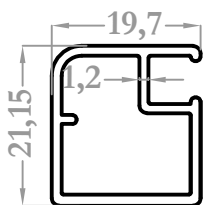

8301
0,301 kg/m

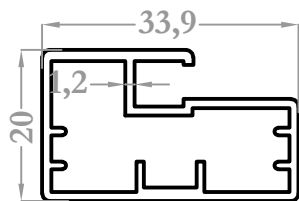

8324
0,430 kg/m

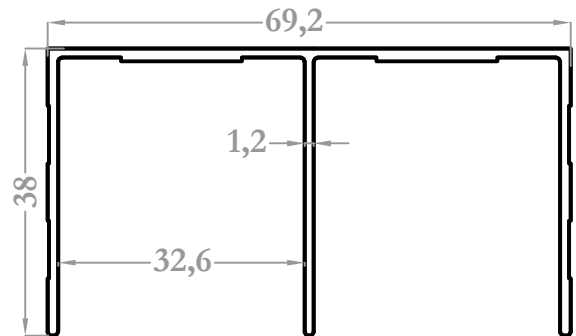

8289
0,650 kg/m

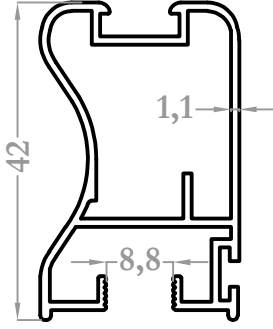

8323
0,525 kg/m

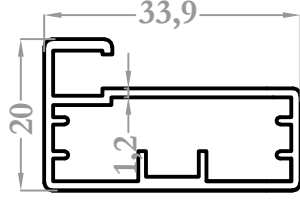

8325
0,400 kg/m

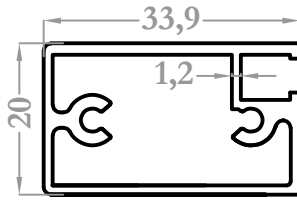

8326
0,507 kg/m

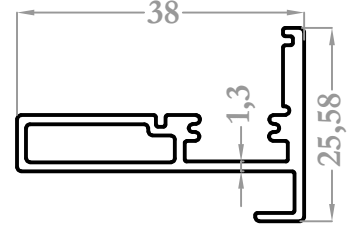

8333
0,430 kg/m

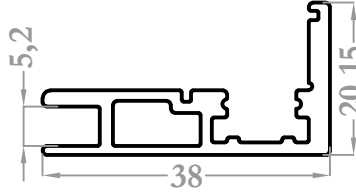

8334
0,479 kg/m

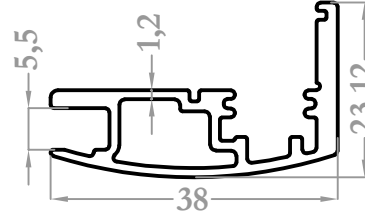

8335
0,493 kg/m

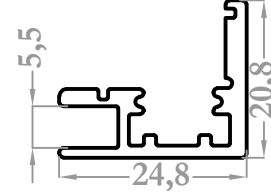

8336
0,340 kg/m

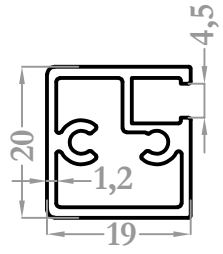

8339
0,363 kg/m



8349
0,230 kg/m

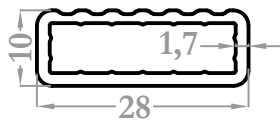

8350
0,300 kg/m

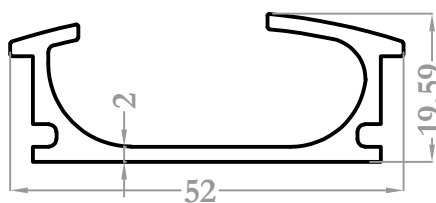

8351
0,633 kg/m

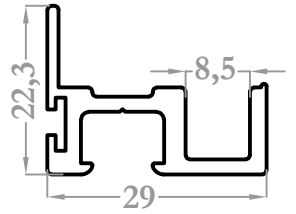

8354
0,436 kg/m

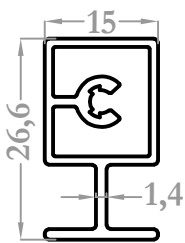

8355
0,328 kg/m

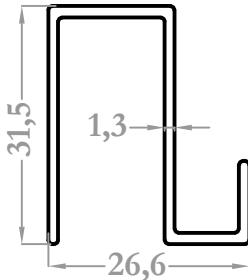

8356
0,355 kg/m

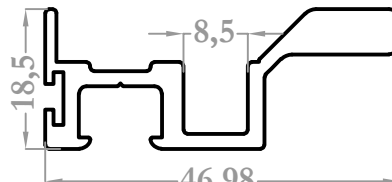

8368
0,670 kg/m

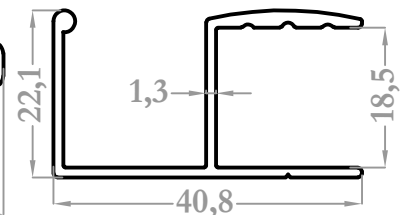

8390
0,392 kg/m

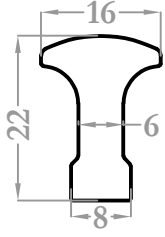

8394
0,495 kg/m

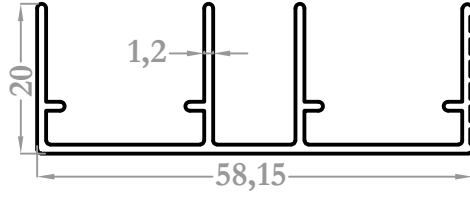

8391
0,460 kg/m

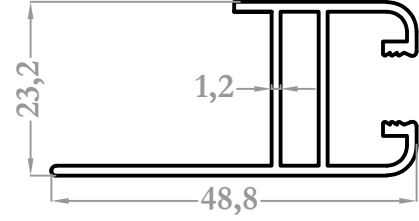

8395
0,450 kg/m

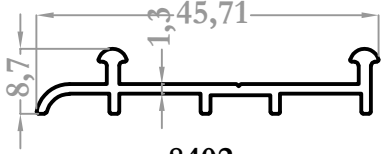

8402
0,258 kg/m

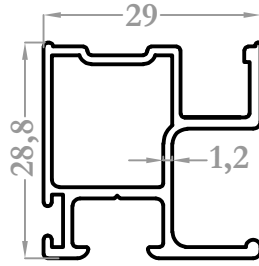

8491
0,468 kg/m

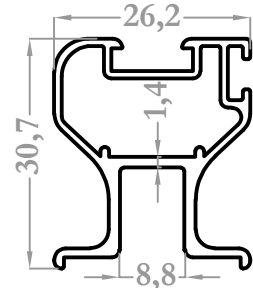

8510
0,436 kg/m

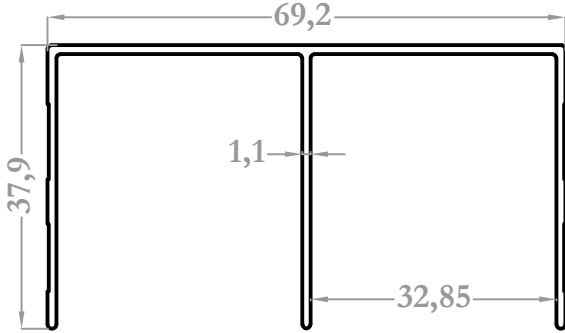

8511
0,552 kg/m

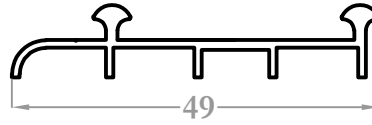

8512
0,252 kg/m

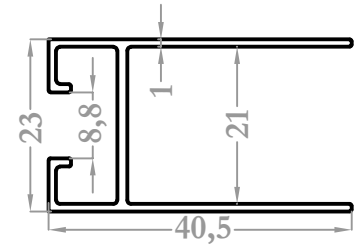

8513
0,340 kg/m

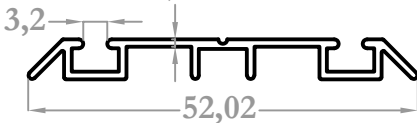

8514
0,242 kg/m

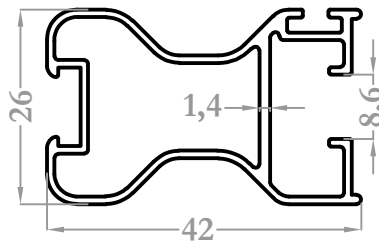

8515
0,495 kg/m

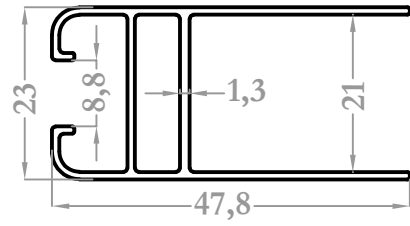

8516
0,427 kg/m

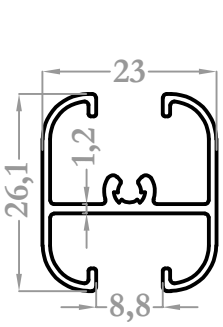

8517
0,308 kg/m

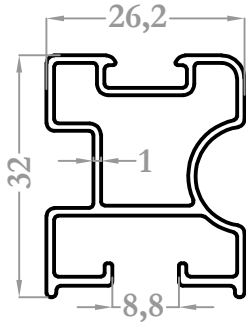

8518
0,425 kg/m

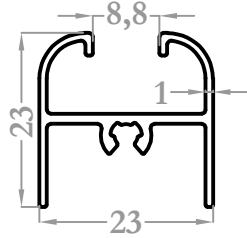

8520
0,263 kg/m

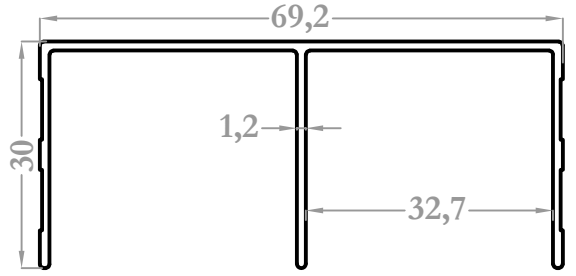

8519
0,494 kg/m

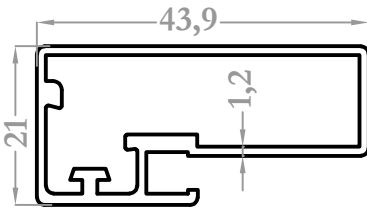

8522
0,526 kg/m

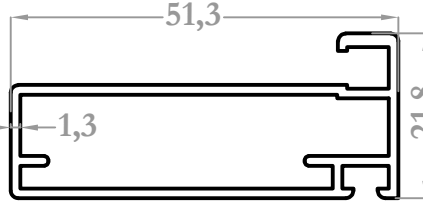

8545
0,555 kg/m

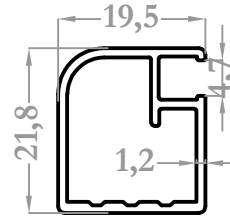

8565
0,275 kg/m

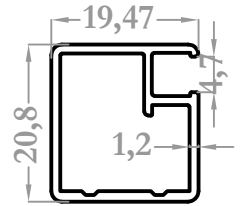

8566
0,268 kg/m

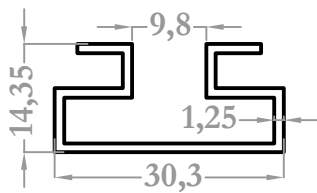

8576
0,287 kg/m

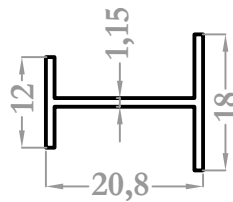

8639
0,220 kg/m

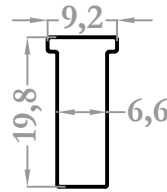

8651
0,367 kg/m

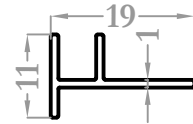

9633
0,095 kg/m

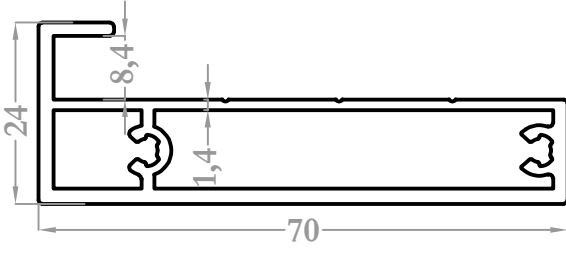

8679
0,954 kg/m

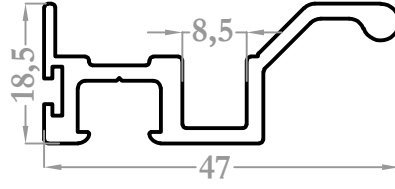

8695
0,560 kg/m

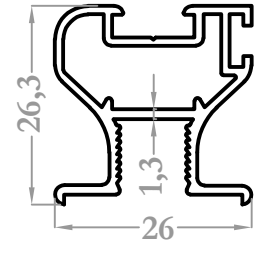

8746
0,404 kg/m

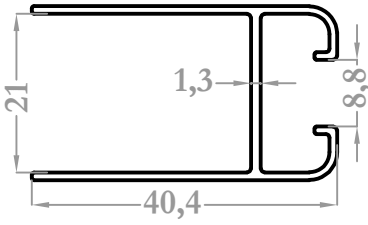

8747
0,330 kg/m

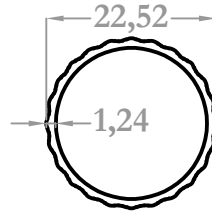

8828
0,192 kg/m

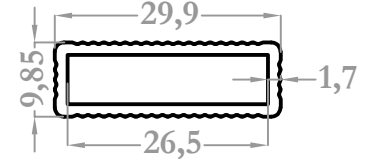

8829
0,306 kg/m

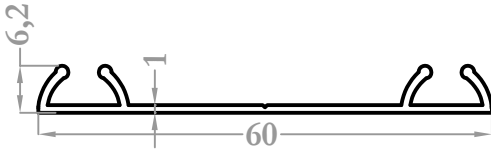

8773
0,244 kg/m

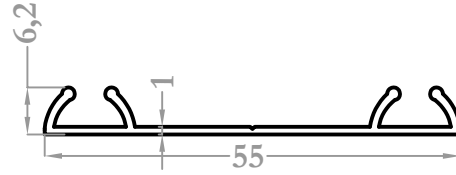

8772
0,231 kg/m

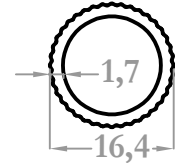

8830
0,194 kg/m

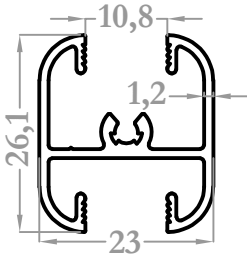

8851
0,362 kg/m

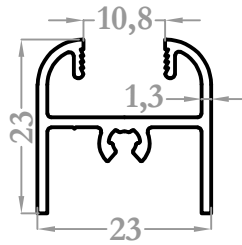

8852
0,313 kg/m

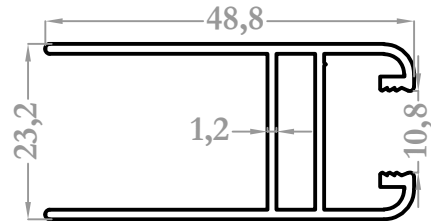

8853
0,528 kg/m

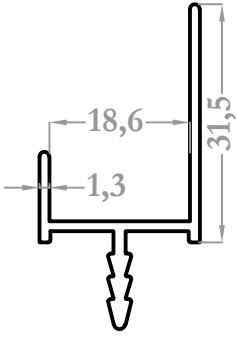

8879
0,292 kg/m

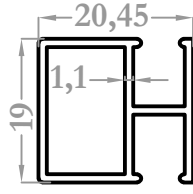

8872
0,260 kg/m

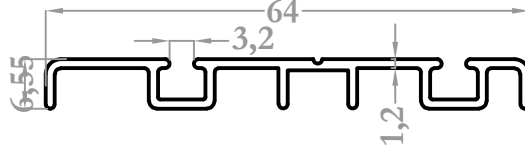

8885
0,363 kg/m

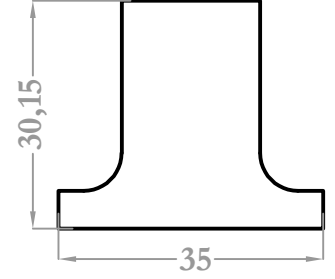

8887
1,747 kg/m

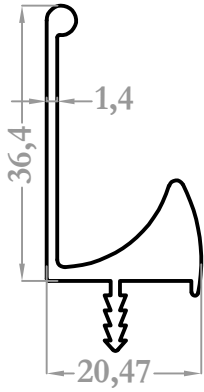

8888
0,515 kg/m

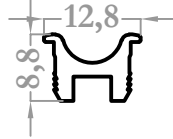

8903
0,135 kg/m

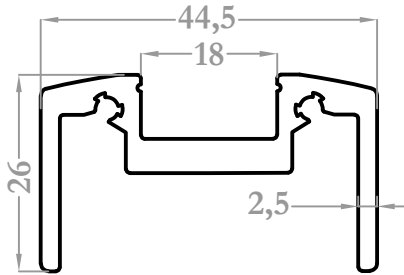

8908
0,883 kg/m

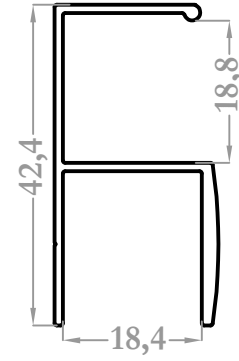

8935
0,352 kg/m

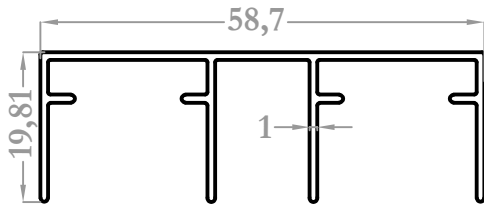

8934
0,403 kg/m

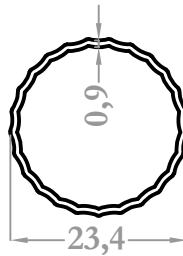

8938
0,174 kg/m

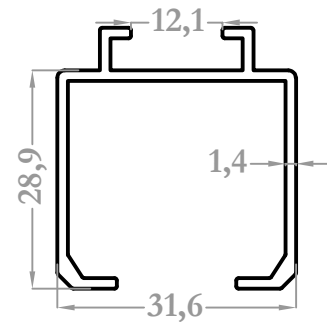

8939
0,444 kg/m

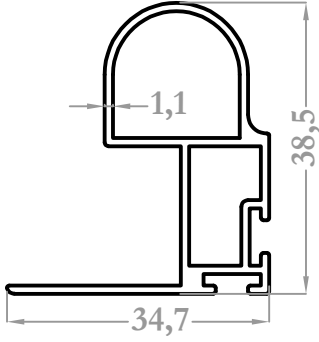

8940
0,459 kg/m

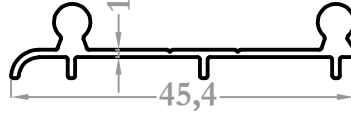

8941
0,276 kg/m

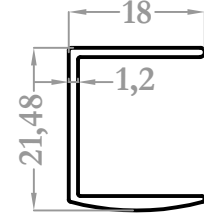

8964
0,189 kg/m

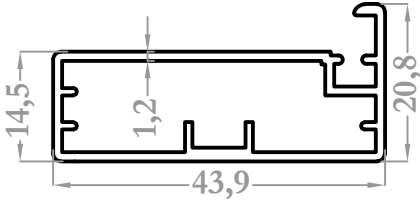

8989
0,466 kg/m

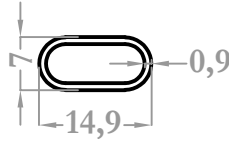

8990
0,085 kg/m

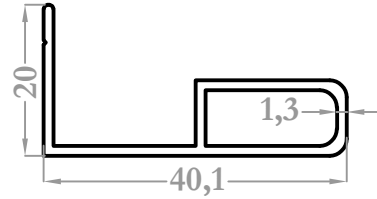

9027
0,327 kg/m

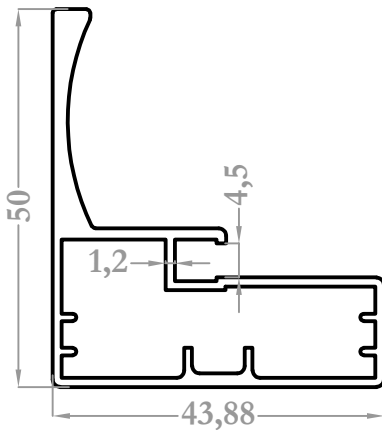

8645
0,747 kg/m

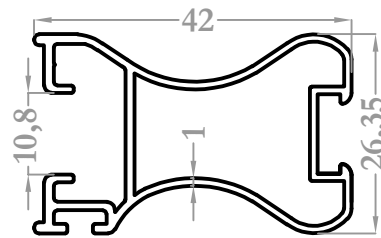

8850
0,455 kg/m

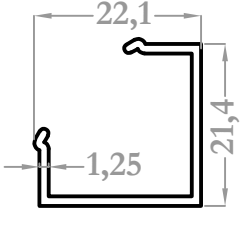

8104
0,204 kg/m

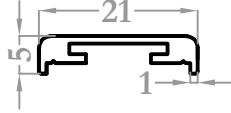

8109
0,132 kg/m

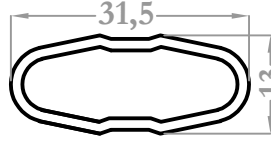

8133
0,287 kg/m

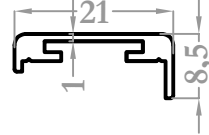

8142
0,141 kg/m

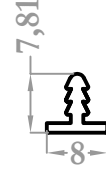

8146
0,066 kg/m



8147
0,079 kg/m

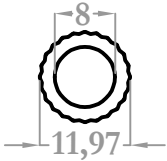

8149
0,157 kg/m

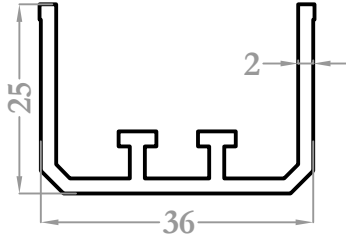

8161
0,529 kg/m

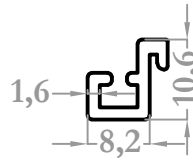

8211
0,127 kg/m

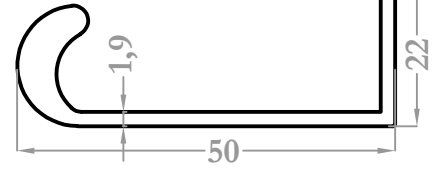

8221
0,543 kg/m

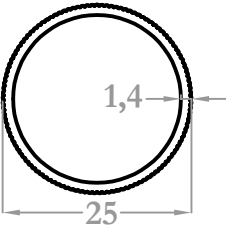

8235
0,262 kg/m

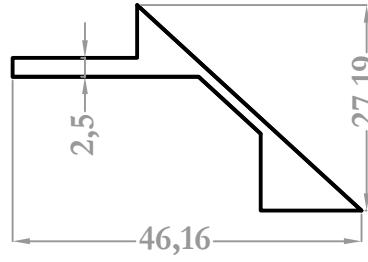

8277
0,347 kg/m

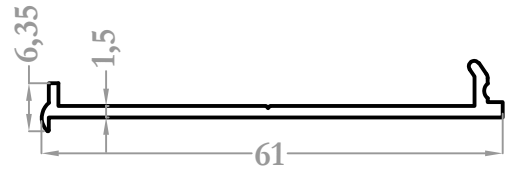

8303
0,290 kg/m

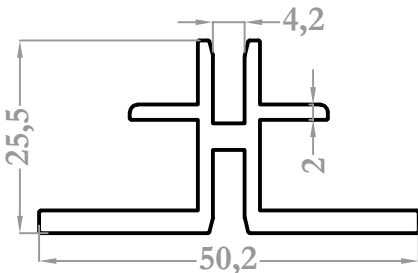

8318
0,749 kg/m

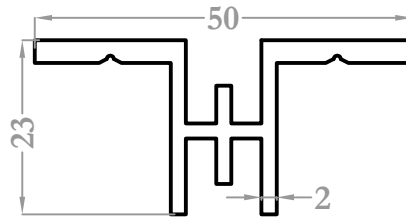

8217
0,649 kg/m

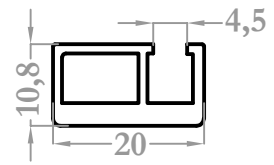

8327
0,285 kg/m

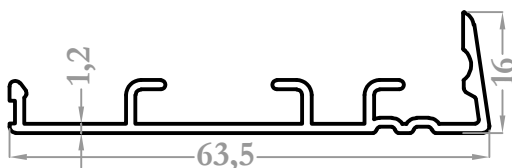

8304
0,390 kg/m

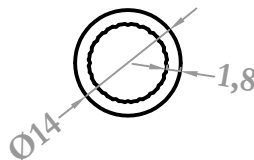

8347
0,190 kg/m

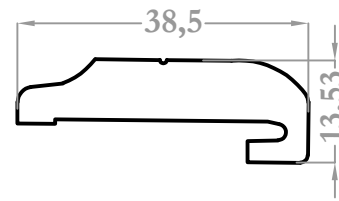

8353
0,536 kg/m

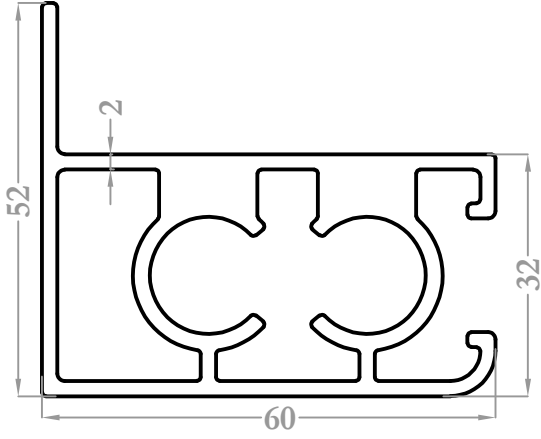

8319
1,897 kg/m

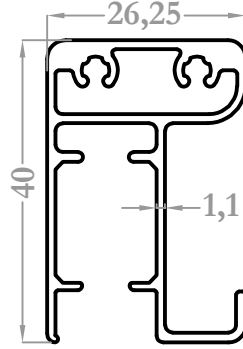

8328
0,616 kg/m

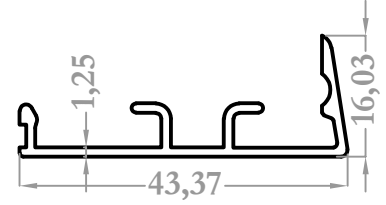

8375
0,286 kg/m

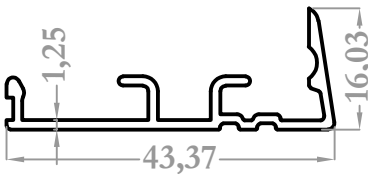

8376
0,290 kg/m

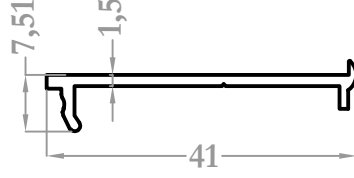

8378
0,206 kg/m

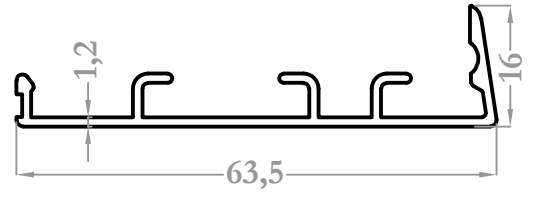

8377
0,383 kg/m

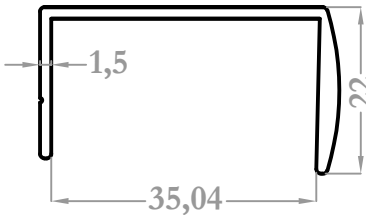

8379
0,357 kg/m

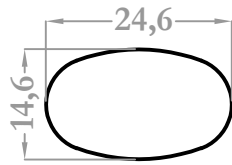

8385
0,791 kg/m

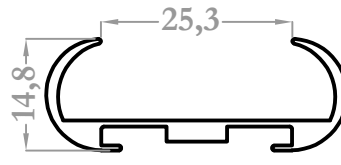

8386
0,308 kg/m

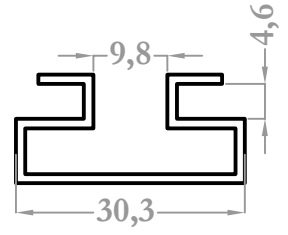

8576
0,287 kg/m

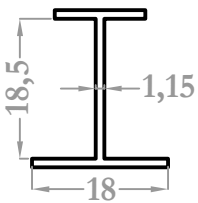

8639
0,220 kg/m

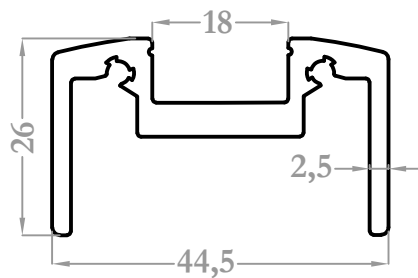

8908
0,883 kg/m

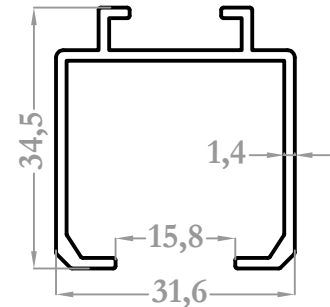

8939
0,444 kg/m

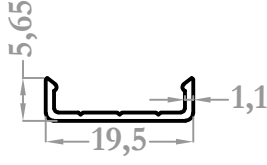

5033
0,081 kg/m

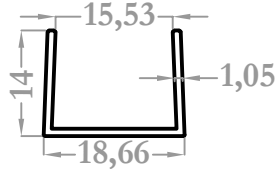

5034
0,122 kg/m

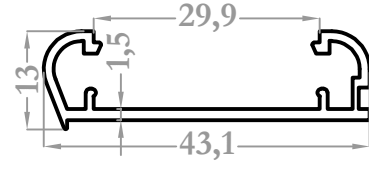

8102
0,301 kg/m

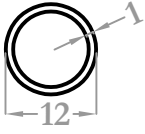

487
0,094 kg/m

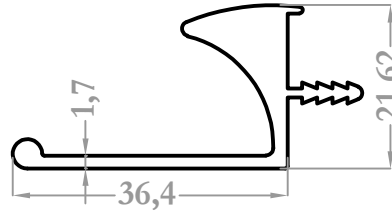

8130
0,564 kg/m

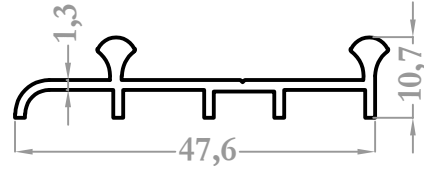

8163
0,319 kg/m

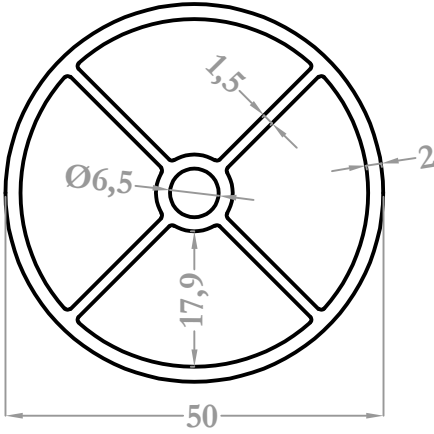

8122
1,242 kg/m

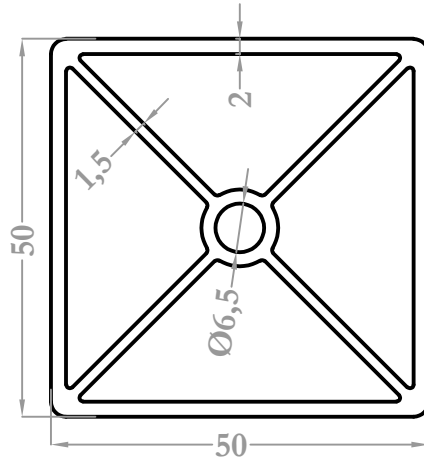

8121
1,601 kg/m

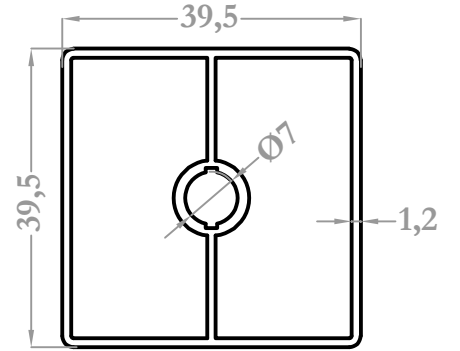

9123
0,679 kg/m

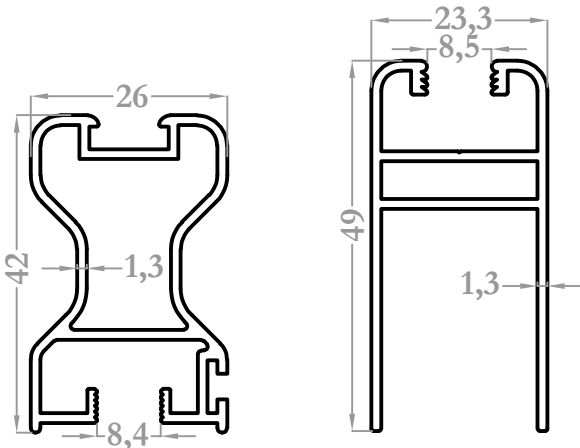

8246
0,599 kg/m

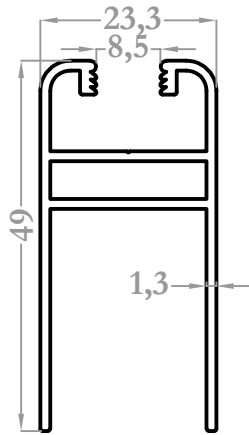

8263
0,556 kg/m

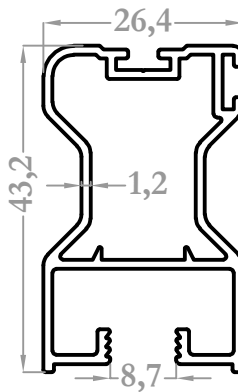

8264
0,589 kg/m

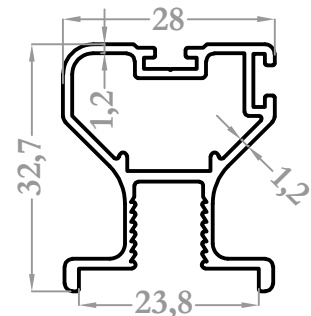

8265
0,537 kg/m

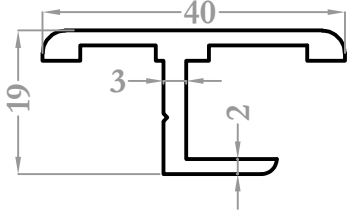

8190
0,482 kg/m

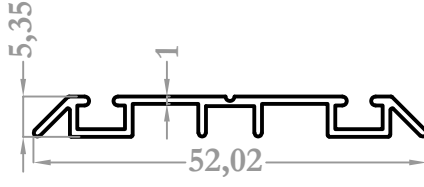

8514
0,240 kg/m

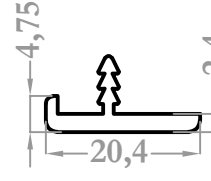

8288
0,178 kg/m

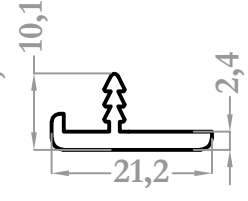

8398
0,182 kg/m

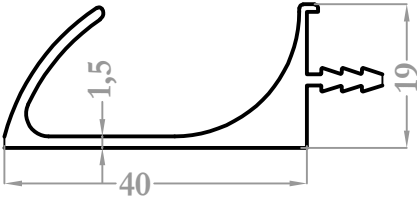

8317
0,529 kg/m

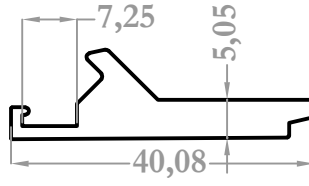

8408
0,557 kg/m

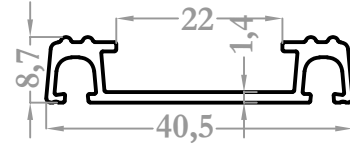

8340
0,280 kg/m

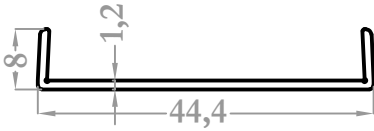

8372
0,185 kg/m

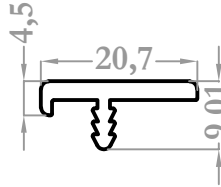

8626
0,185 kg/m

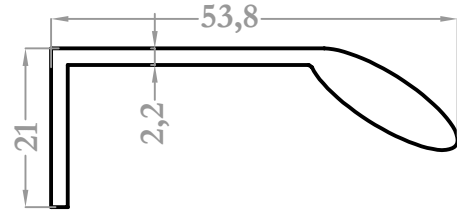

8632
0,656 kg/m

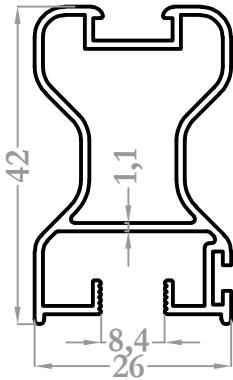

8247
0,515 kg/m

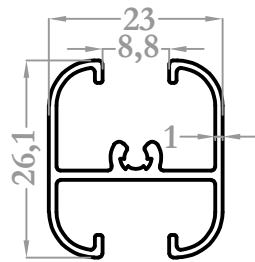

8517
0,308 kg/m

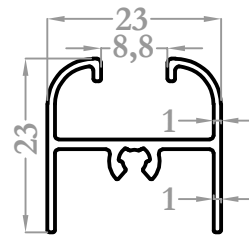

8520
0,263 kg/m

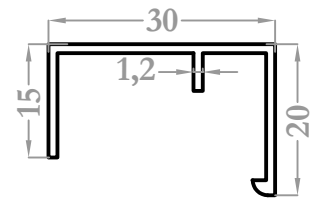

8625
0,227 kg/m

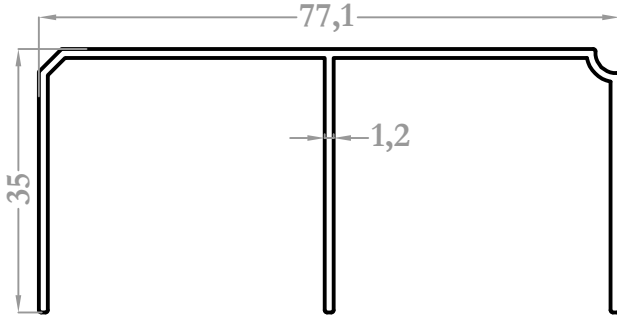

8658
0,576 kg/m

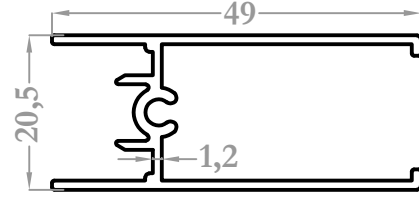

8660
0,457 kg/m

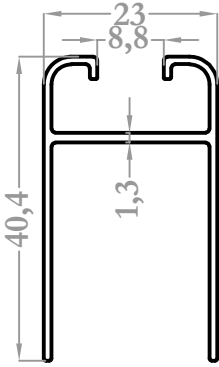

8747
0,330 kg/m

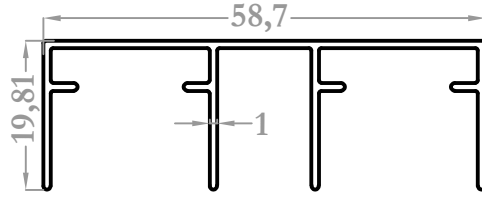

8934
0,403 kg/m

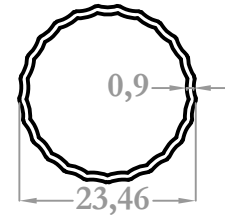

8938
0,174 kg/m

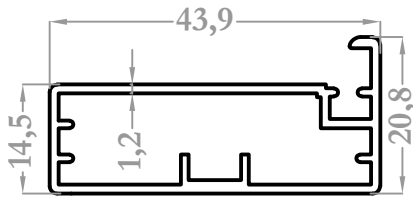

8989
0,466 kg/m

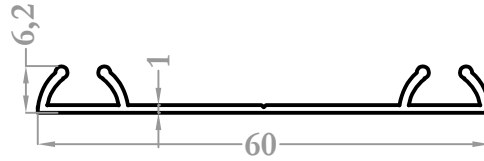

8773
0,244 kg/m

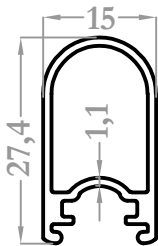

9131
0,268 kg/m

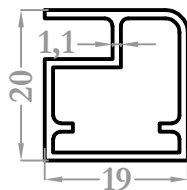

9045
0,262 kg/m

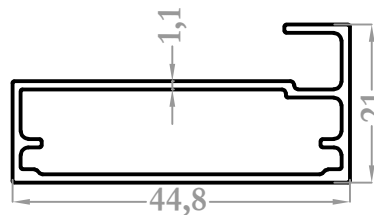

9041
0,412 kg/m

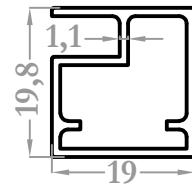

9044
0,264 kg/m

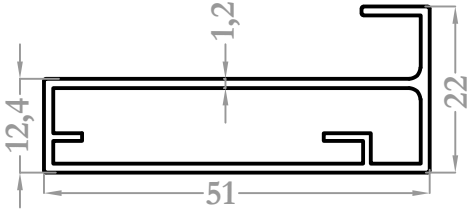

9042
0,491 kg/m

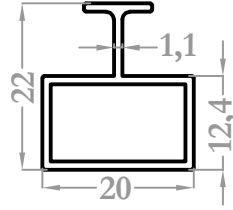

9043
0,233 kg/m

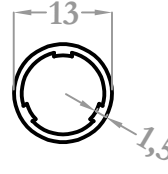

9046
0,111 kg/m

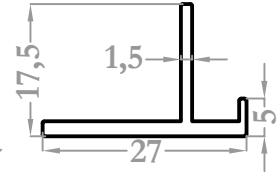

9076
0,217 kg/m

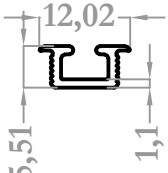

9078
0,070 kg/m

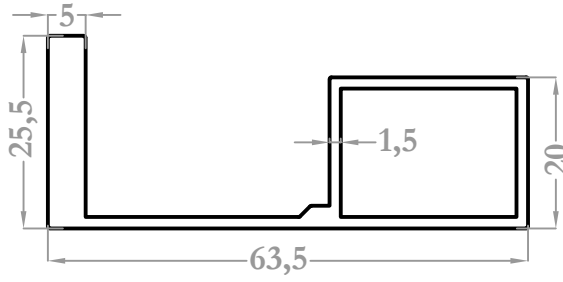

9077
0,841 kg/m

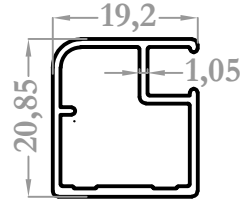

9116
0,250 kg/m

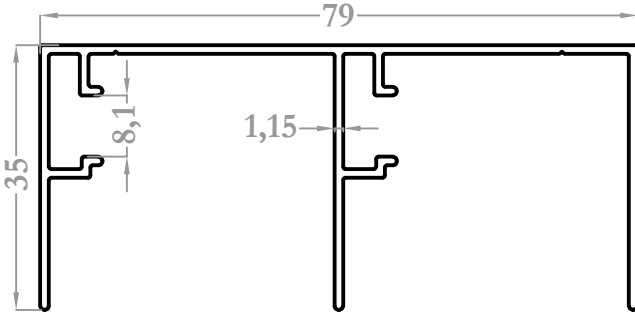

9080
0,706 kg/m

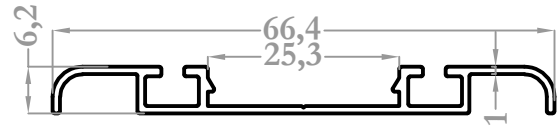

9117
0,295 kg/m

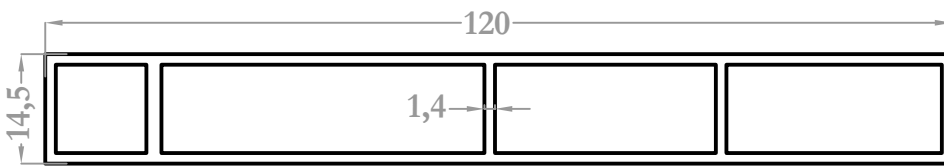

9111
1,151 kg/m

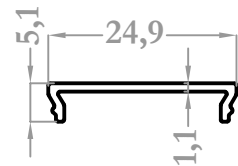

9118
0,101 kg/m

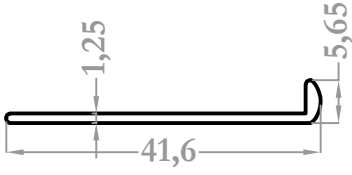

9163
0,157 kg/m

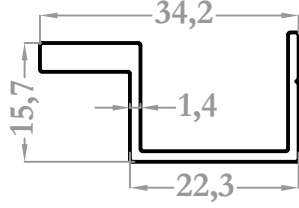

9185
0,321 kg/m

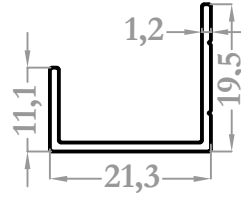

9186
0,161 kg/m

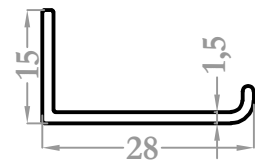

9269
0,179 kg/m

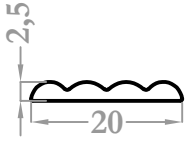

9313
0,113 kg/m

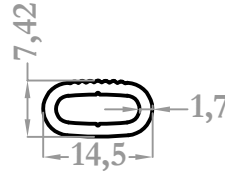

9155
0,146 kg/m

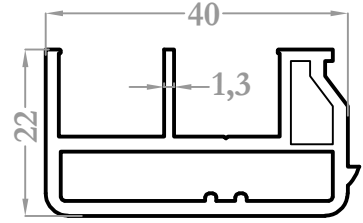

9225
0,787 kg/m

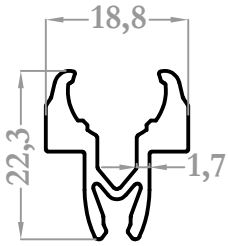

9315
0,361 kg/m

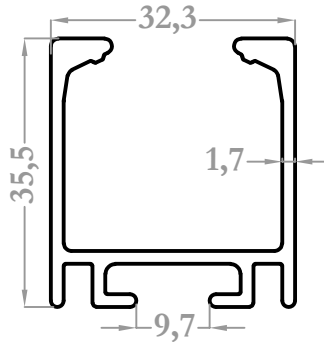

9326
0,666 kg/m

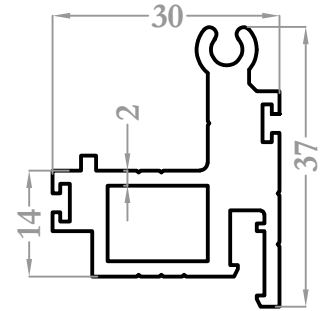

9485
0,960 kg/m

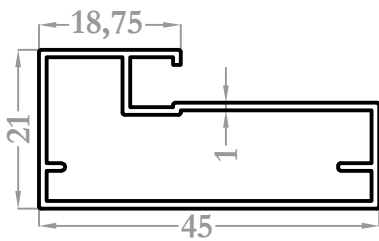

9338
0,388 kg/m

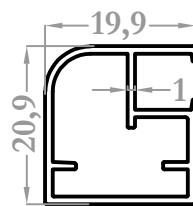

9339
0,249 kg/m

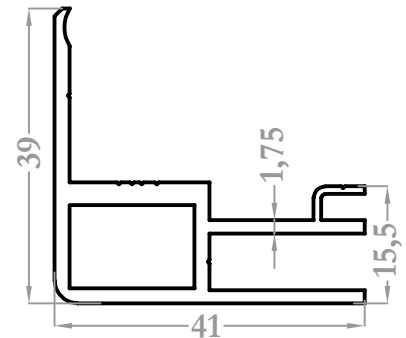

9486
0,728 kg/m



9156
3,460 kg/m

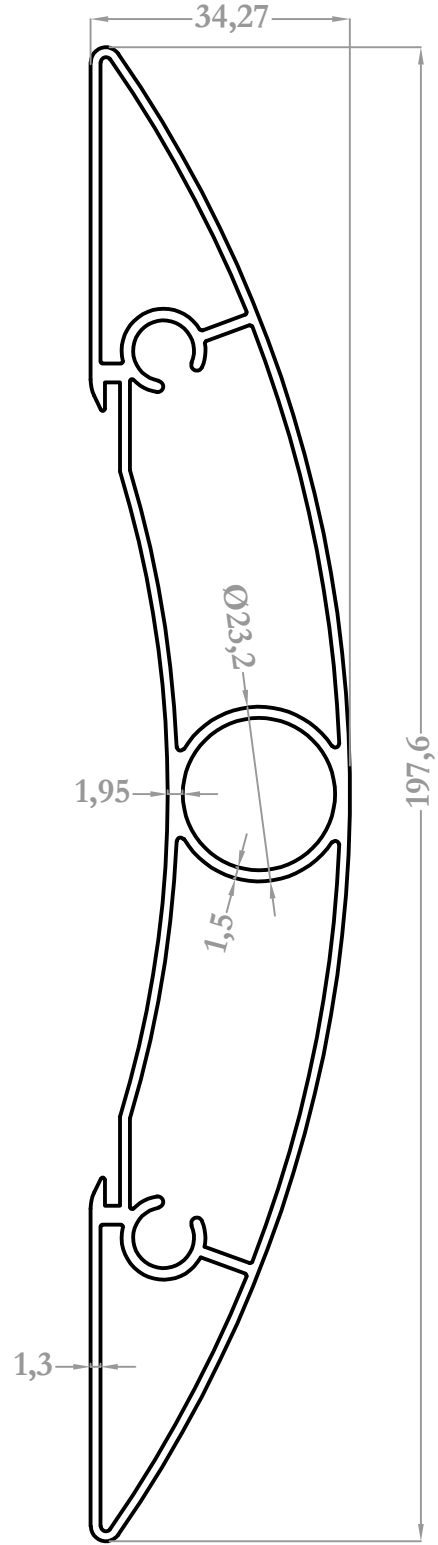

9158
2,029 kg/m