

R9058
0,810 kg/m

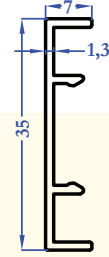

M5178
0,200 kg/m

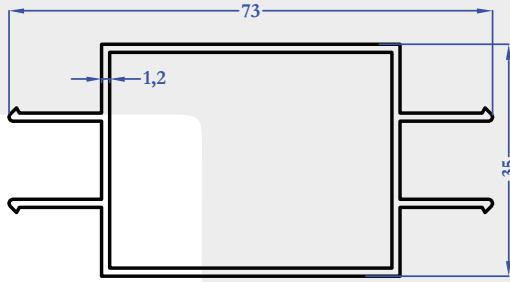

1917
0,692 kg/m

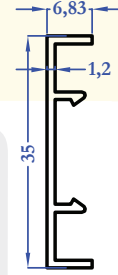

1918
0,183 kg/m

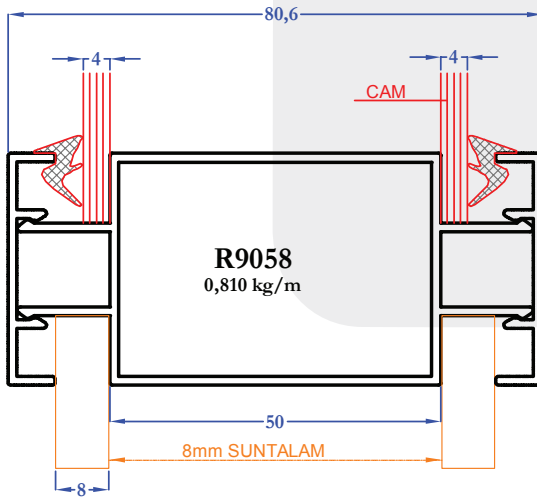

R9058
0,810 kg/m

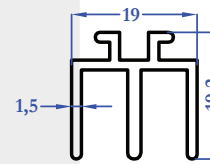

1920
0,305 kg/m

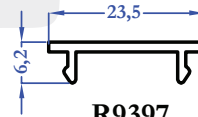

R9397
0,129 kg/m

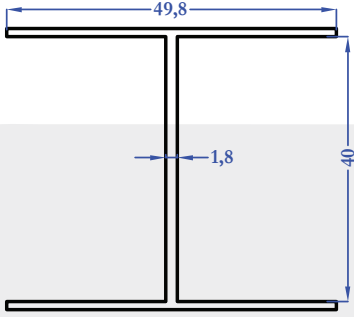

1913
0,520 kg/m

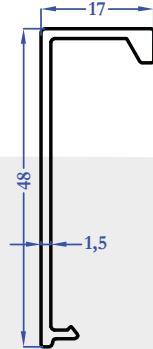

R9056
0,304 kg/m

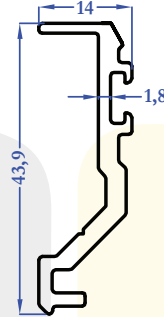

R9055
0,442 kg/m

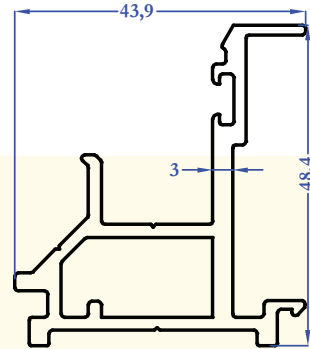

R9057
0,980 kg/m

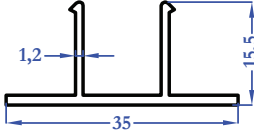

1919
0,236 kg/m

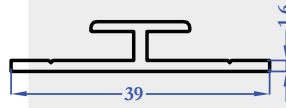

8580
0,252 kg/m

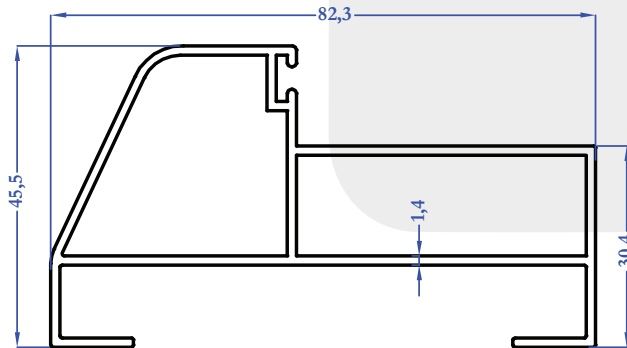
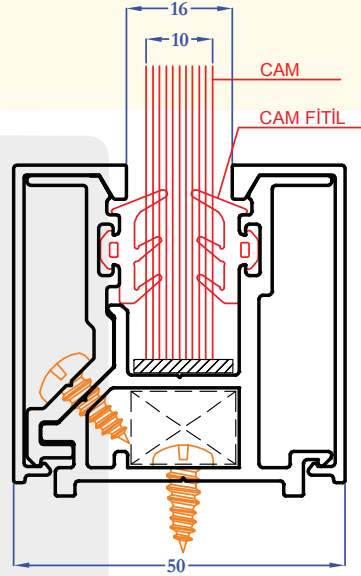

R9022
1.066 kg/m

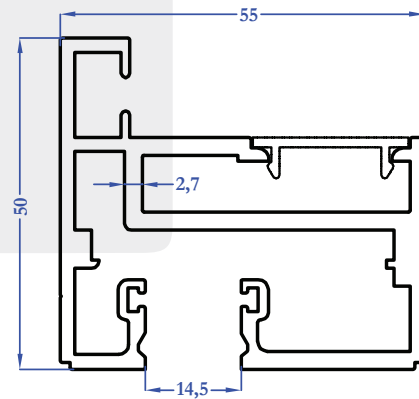

M5461
1.663 kg/m

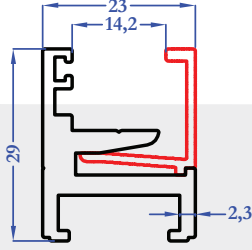

M5459
0,577 kg/m

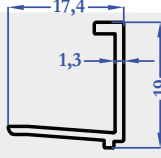

M5460
0,138 kg/m

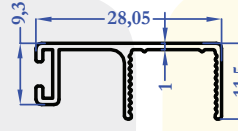

M5637
0,165 kg/m

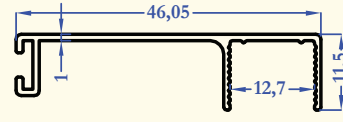

M5636
0,215 kg/m

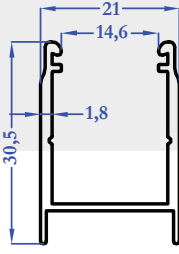

R9375
0,321 kg/m

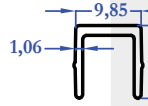

8387
0,095 kg/m

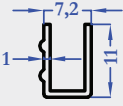

8552
0,075 kg/m

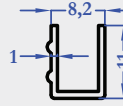

8550
0,080 kg/m

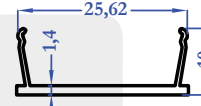

8414
0,130 kg/m

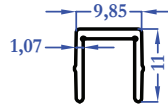

8415
0,094 kg/m

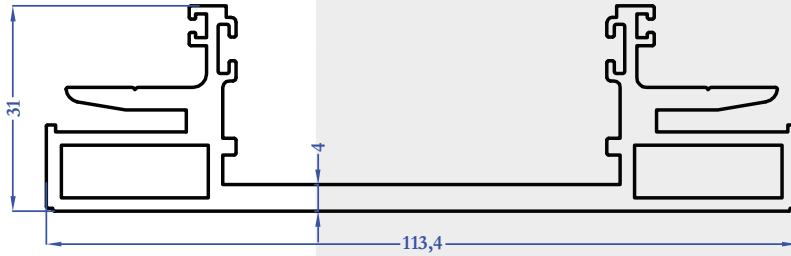

M5639
2,186 kg/m

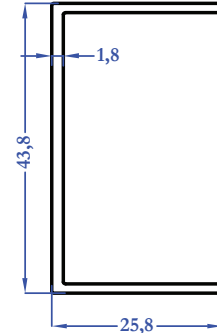

8737
1,463 kg/m

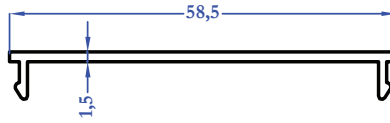

M5638
0,278 kg/m

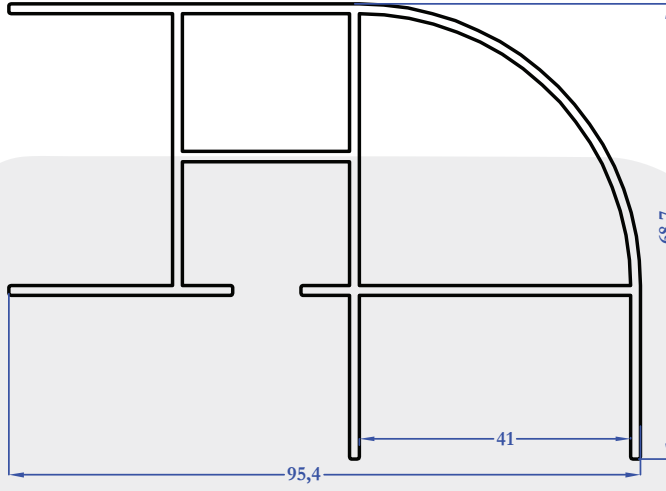

8737
1,463 kg/m

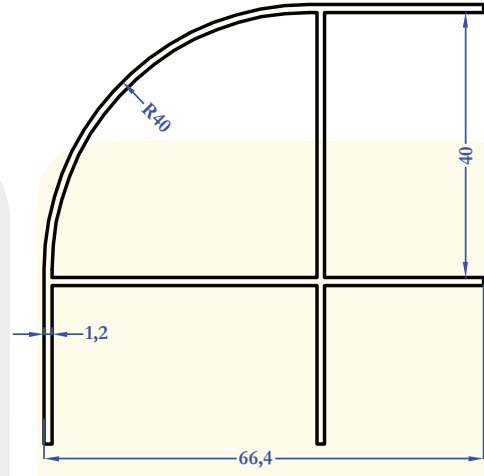

1915
0,793 kg/m

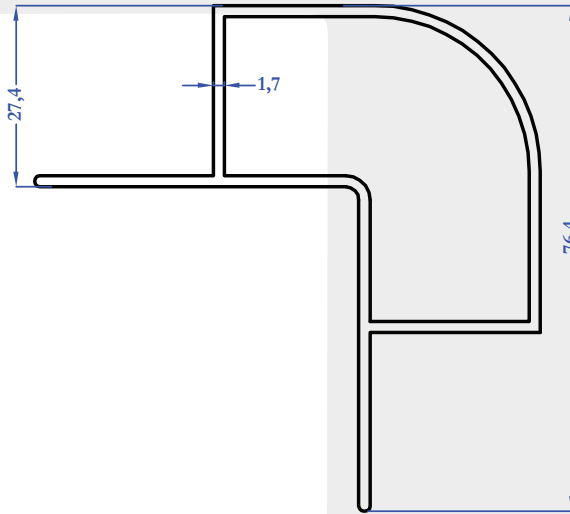

8736
1,072 kg/m

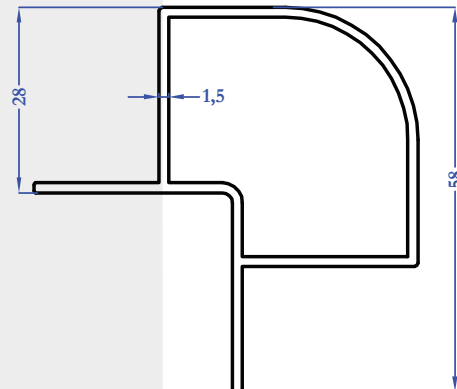

8638
0,726 kg/m

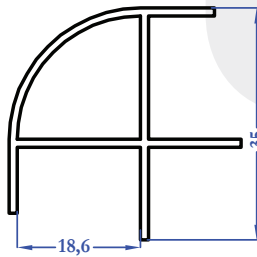

8560
0,386 kg/m

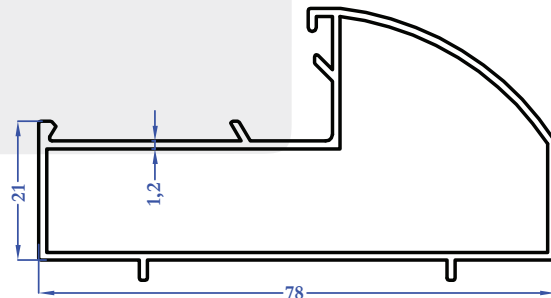

1916
0,776 kg/m

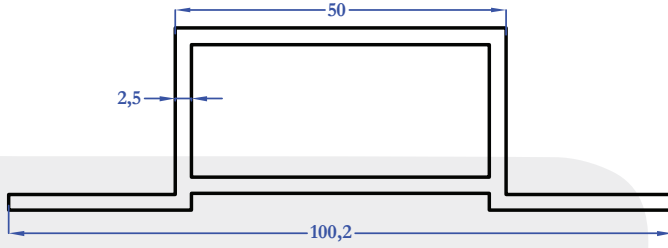

8769
1,295 kg/m

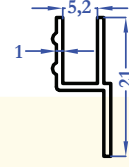

8551
0,107 kg/m

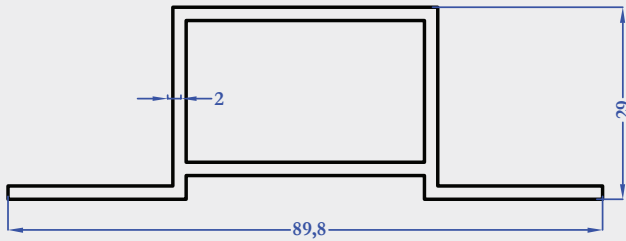

8637
0,974 kg/m

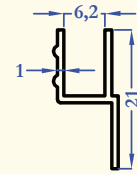

8553
0,110 kg/m

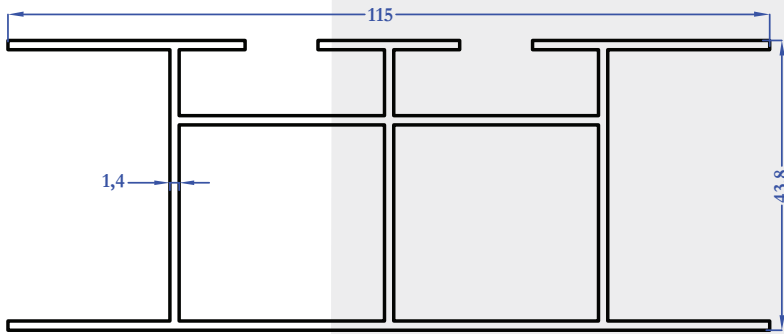

8358
1,491 kg/m

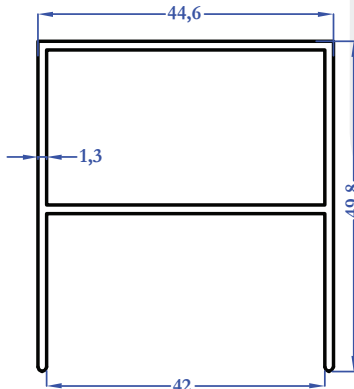

1921
0,645 kg/m

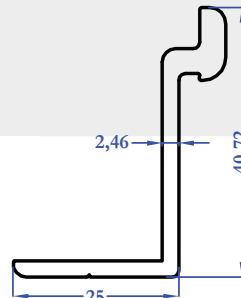

8383
0,519 kg/m

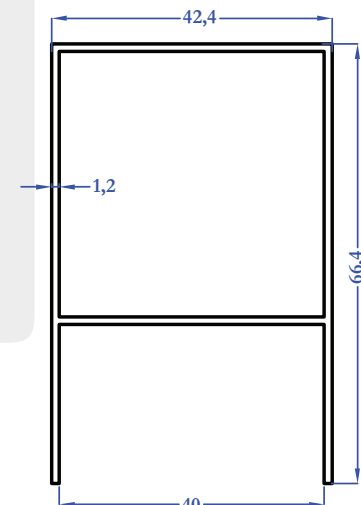

1914
0,692 kg/m

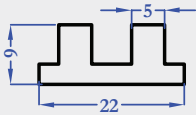

1601
0,341 kg/m

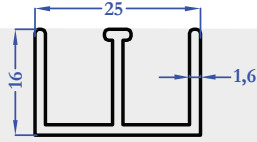

1602
0,303 kg/m

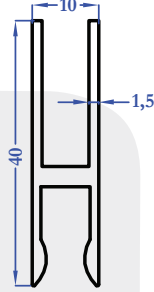

1603
0,378 kg/m

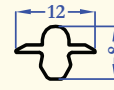

1604
0,103 kg/m

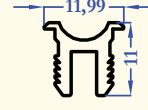

8115
0,144 kg/m

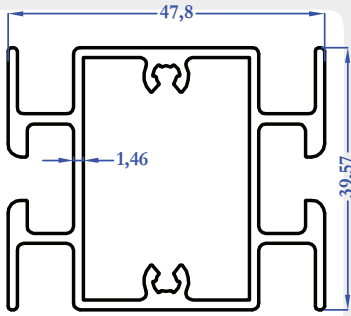

8381
1,093 kg/m

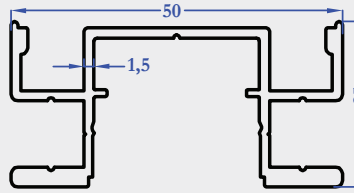

8382
0,655 kg/m

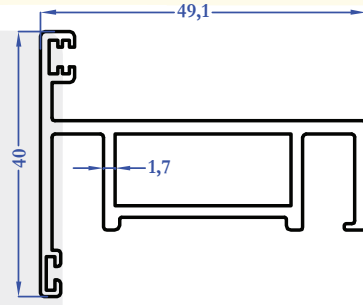

8724
0,806 kg/m

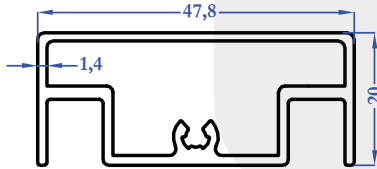

8380
0,640 kg/m

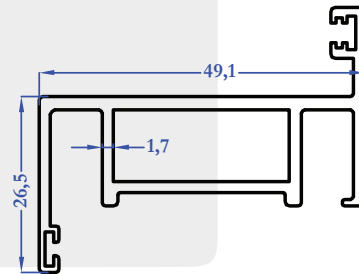

8684
0,807 kg/m