

2907
1,547 kg/m

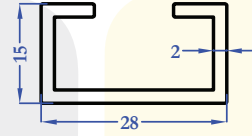

5035
0,357 kg/m

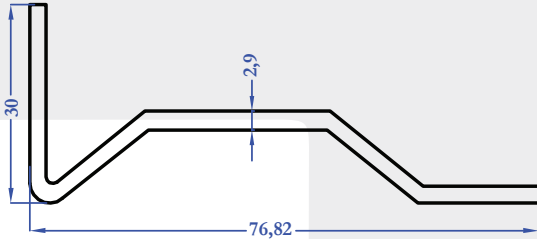

8001
0,777 kg/m

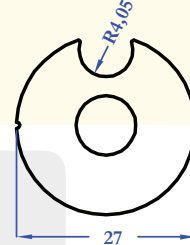

8002
1,291 kg/m

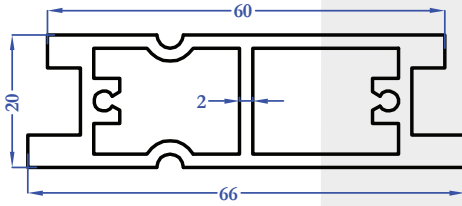

8003
1,263 kg/m

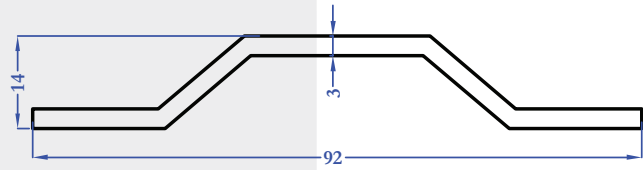

8004
0,813 kg/m

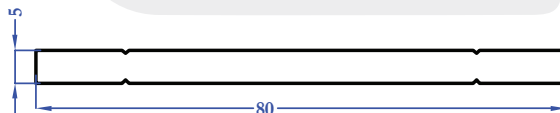

8005
1,081 kg/m

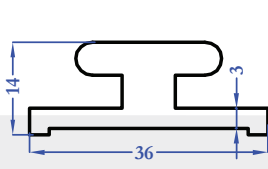

8010
0,700 kg/m

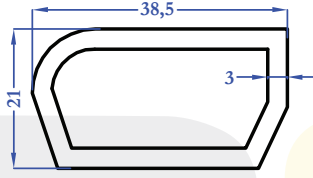

8012
0,793 kg/m

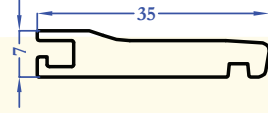

8070
0,485 kg/m

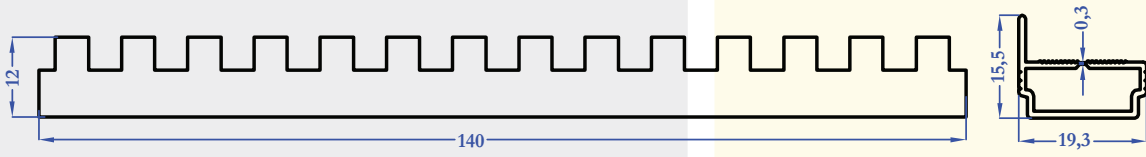

8014
3,600 kg/m

8026
0,153 kg/m

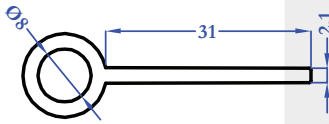

8053
0,386 kg/m

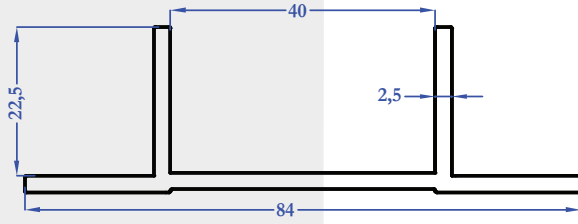

8059
0,874 kg/m

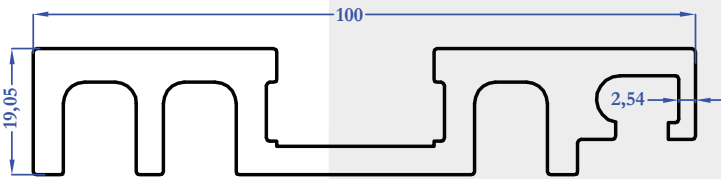

8066
2,388 kg/m

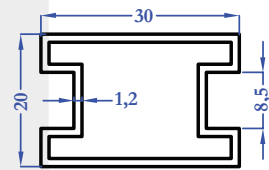

8069
0,375 kg/m

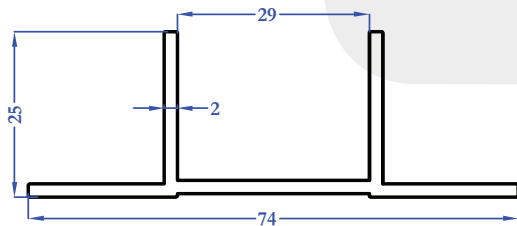

8060
0,650 kg/m

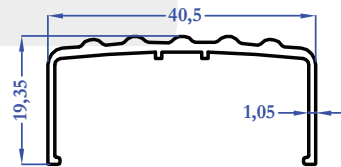

8078
0,289 kg/m

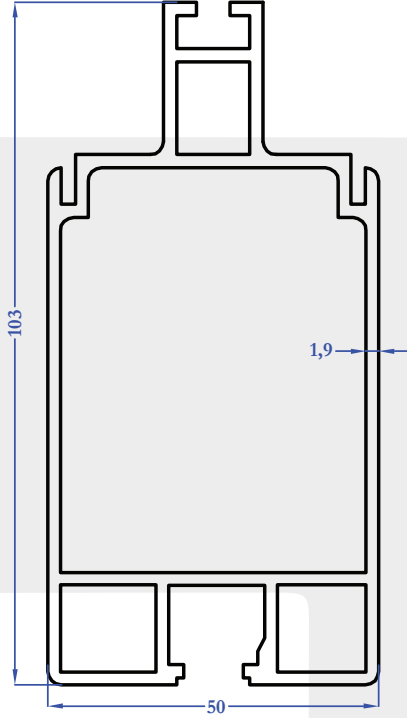

8067
2,059 kg/m

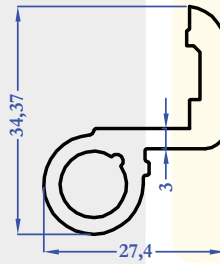

8071
0,630 kg/m

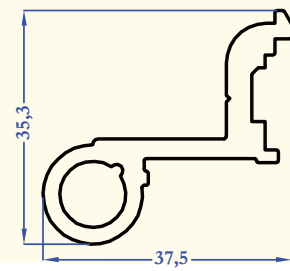

8072
0,730 kg/m

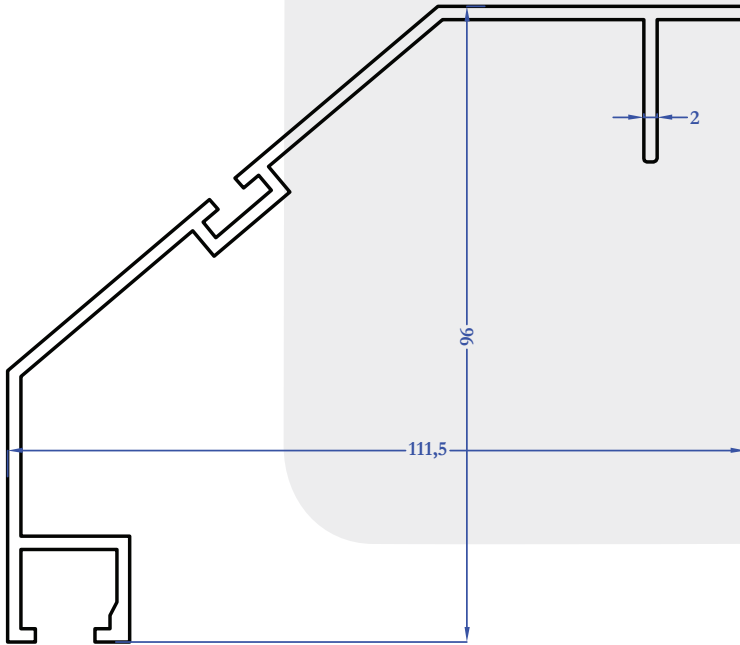

8068
1,333 kg/m

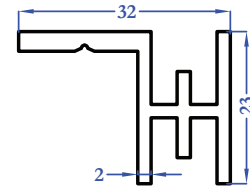

8073
0,504 kg/m

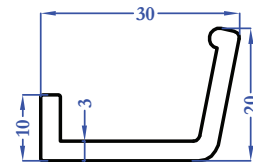

8077
0,418 kg/m

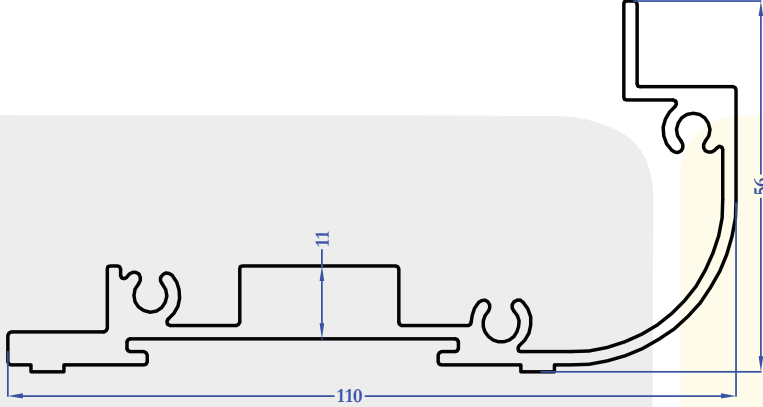

8079
2,102 kg/m

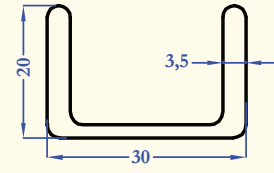

8082
0,495 kg/m

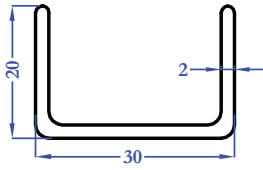

8083
0,355 kg/m

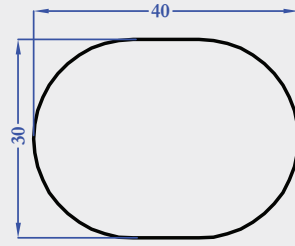

8116
2,726 kg/m

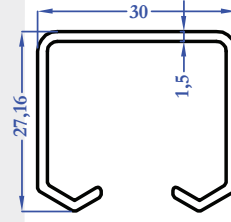

8124
0,375 kg/m

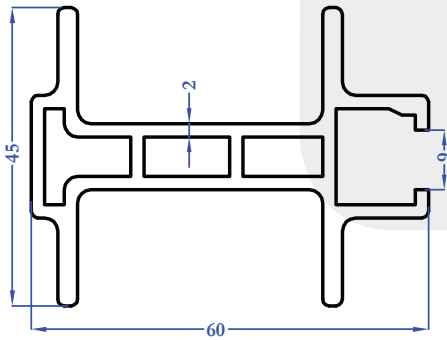

8176
1,394 kg/m

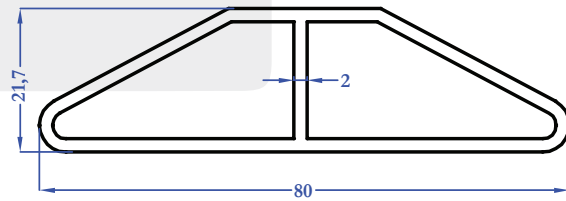

8129
1,016 kg/m

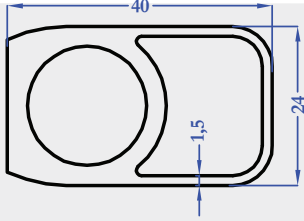

8134
0,940 kg/m

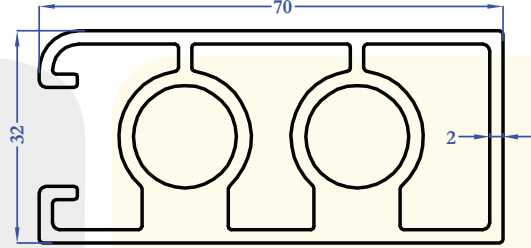

8249
2,071 kg/m

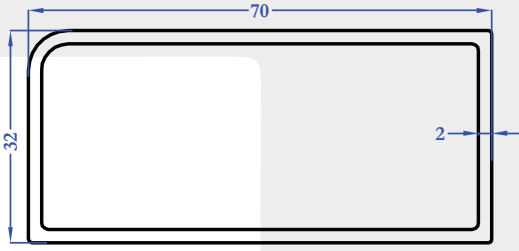

8250
1,052 kg/m

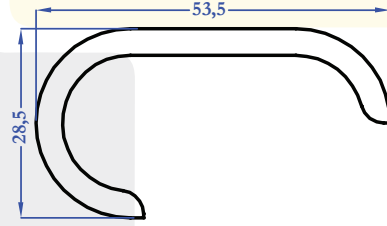

8436
0,907 kg/m

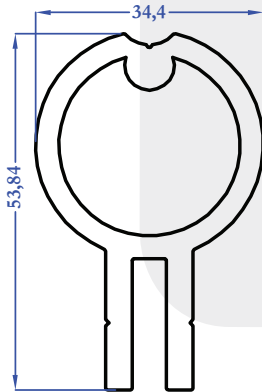

8337
1,424 kg/m

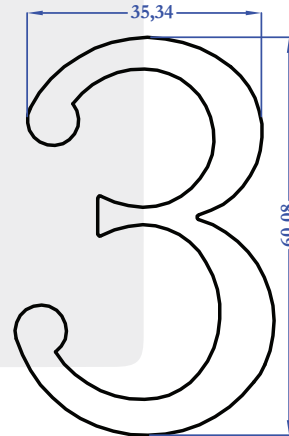

8348
2,175 kg/m

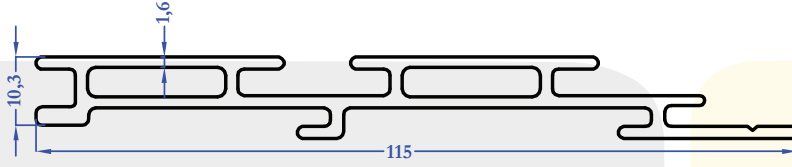

8338
1,140 kg/m

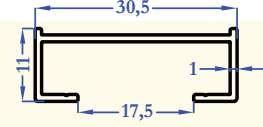

8492
0,165 kg/m

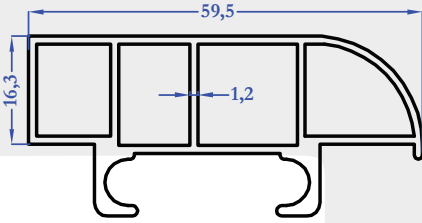

8373
0,792 kg/m

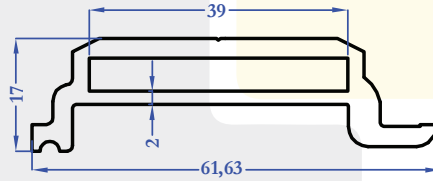

8413
0,982 kg/m

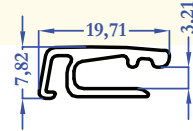

8498
0,162 kg/m

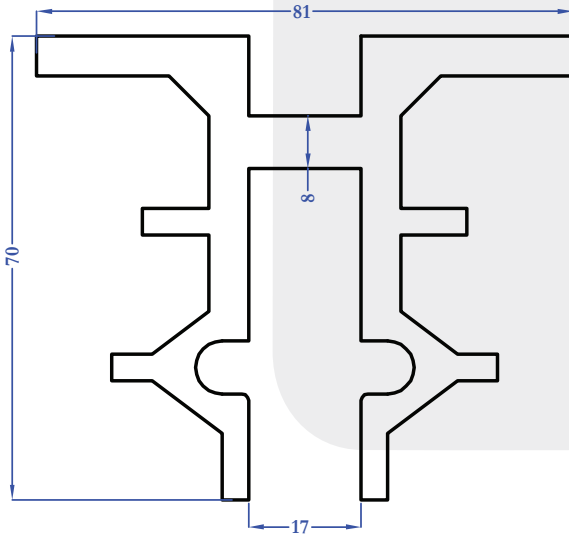

8364
0,999 kg/m

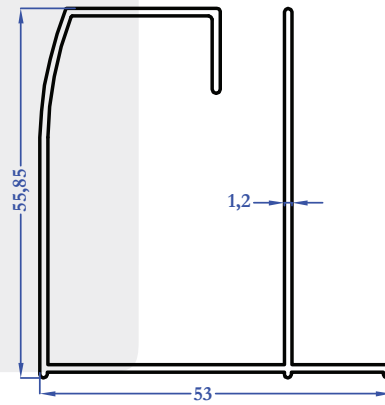

8374
0,640 kg/m

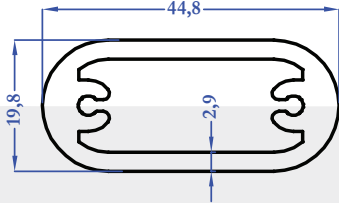

8437
1,037 kg/m

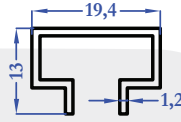

8438
0,172 kg/m

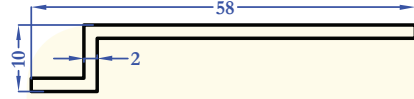

8439
0,357 kg/m

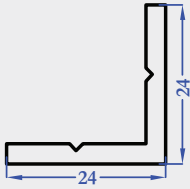

8440
0,360 kg/m

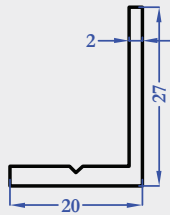

8441
0,290 kg/m

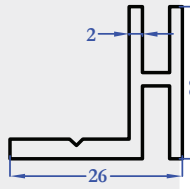

8442
0,410 kg/m

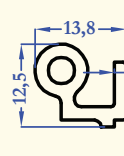

8443
0,203 kg/m

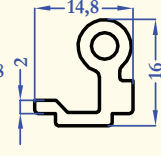

8444
0,246 kg/m

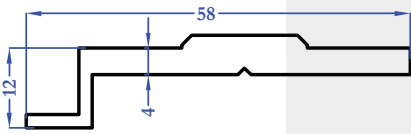

8482
0,723 kg/m

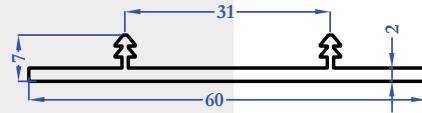

8484
0,370 kg/m

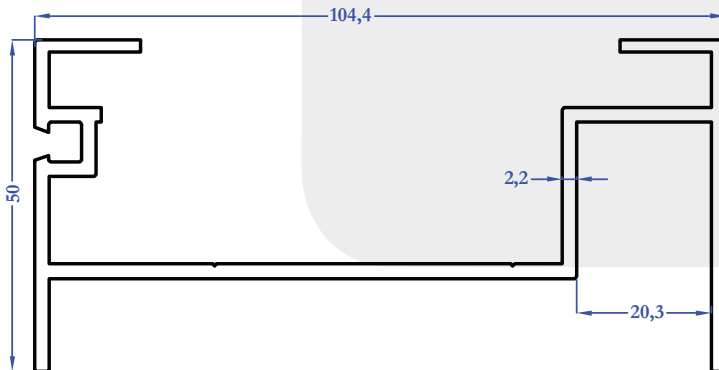

8496
1,566 kg/m

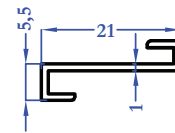

8527
0,100 kg/m

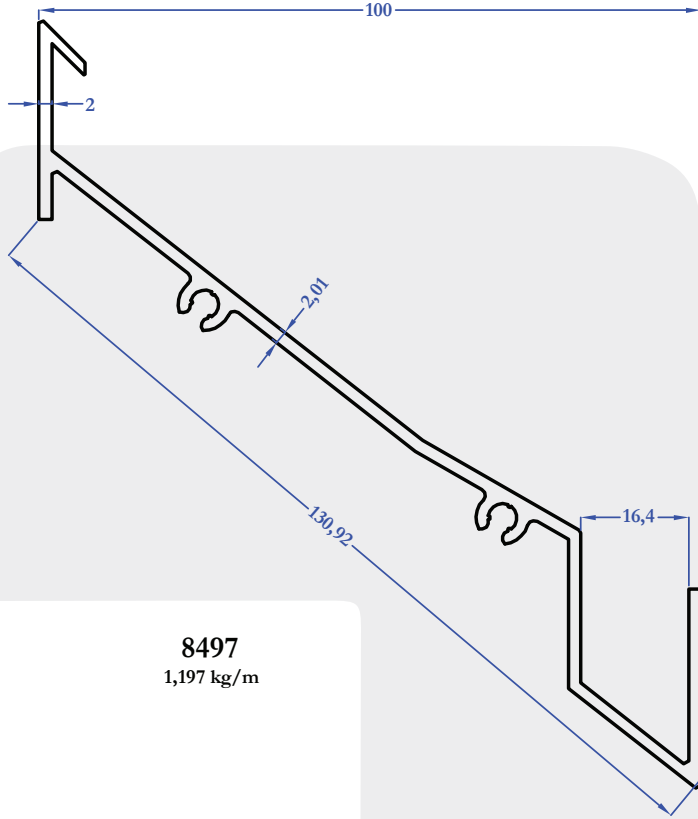

8497
1,197 kg/m

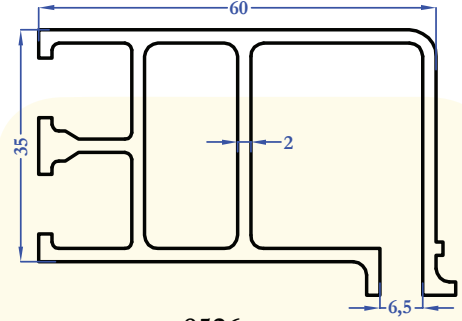

8526
1,365 kg/m

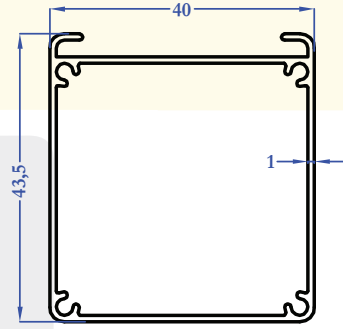

8534
0,496 kg/m

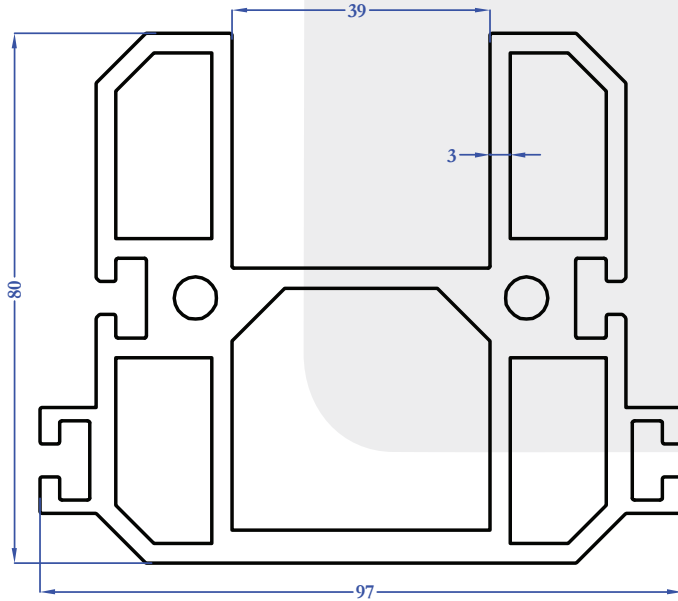

8530
5,361 kg/m

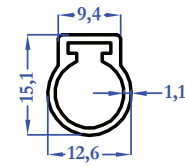

8536
0,152 kg/m

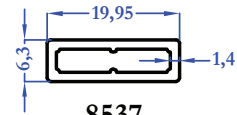

8537
0,181 kg/m

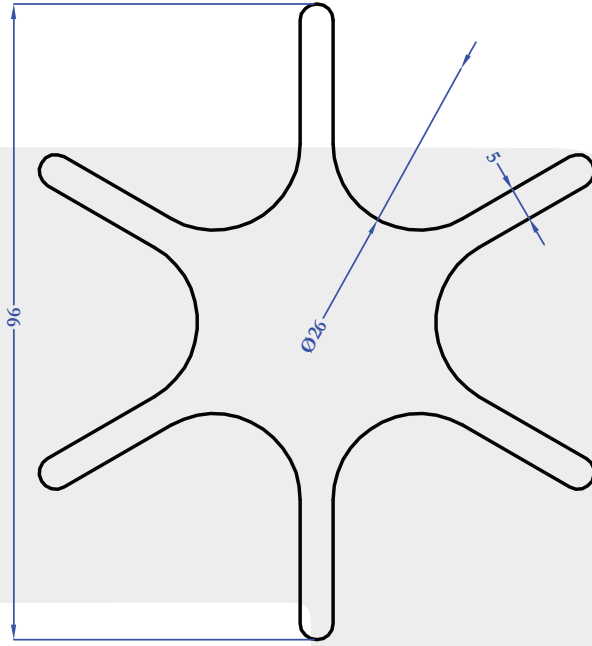

8155
4,038 kg/m

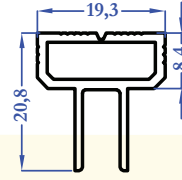

8542
0,260 kg/m

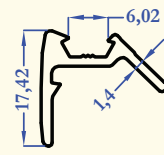

8543
0,183 kg/m

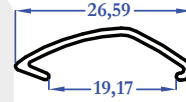

8544
0,100 kg/m

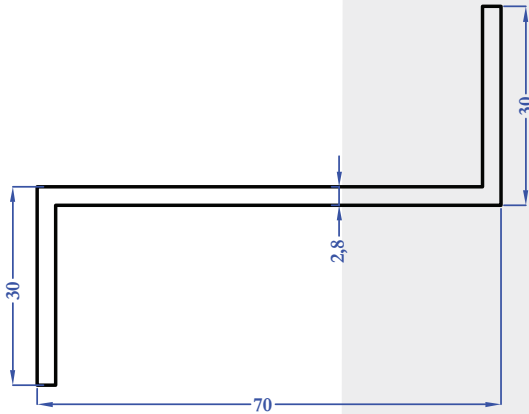

8540
0,943 kg/m

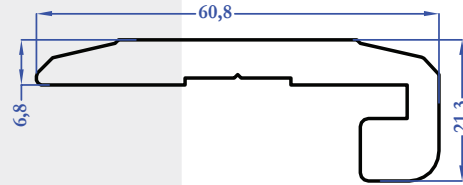

8554
1,297 kg/m

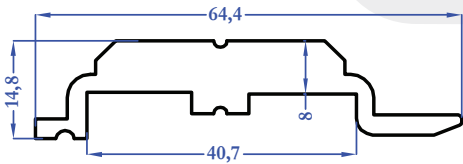

8557
1,124 kg/m

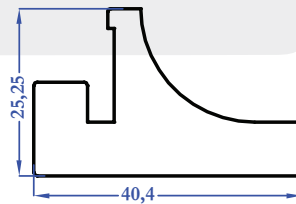

8555
1,384 kg/m

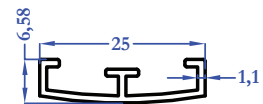

8578
0,134 kg/m

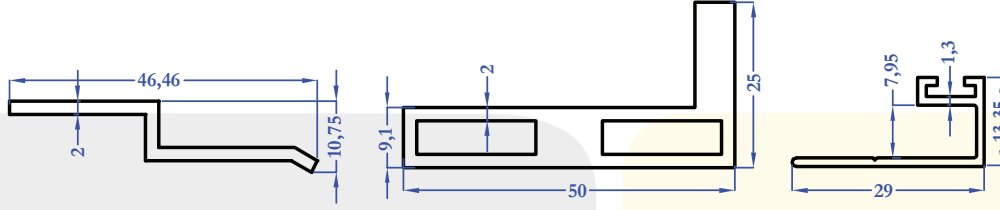

8556
0,289 kg/m

8561
0,994 kg/m

8562
0,195 kg/m

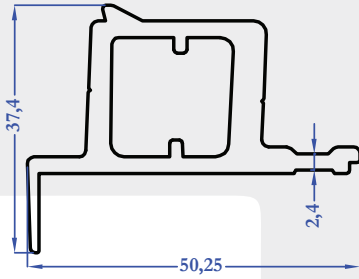

8571
1,060 kg/m

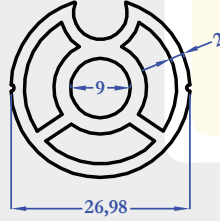

8572
0,728 kg/m

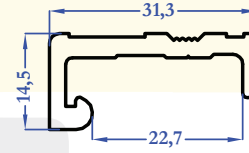

8594
0,406 kg/m

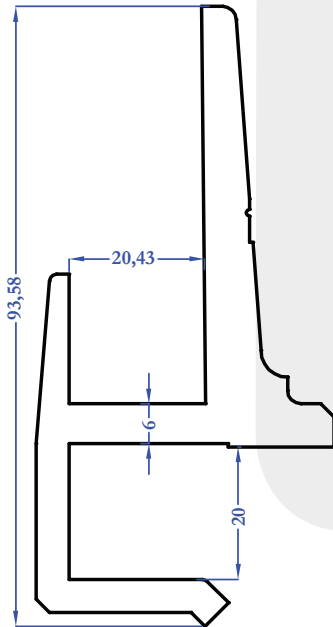

8558
2,744 kg/m

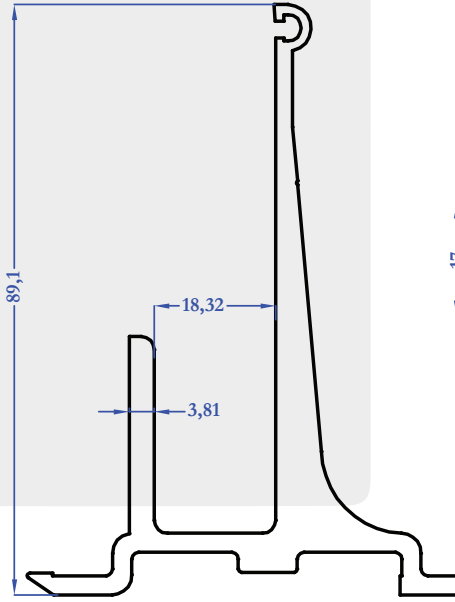

8559
2,067 kg/m

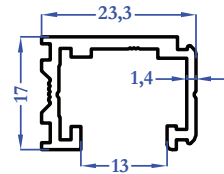

8596
0,294 kg/m

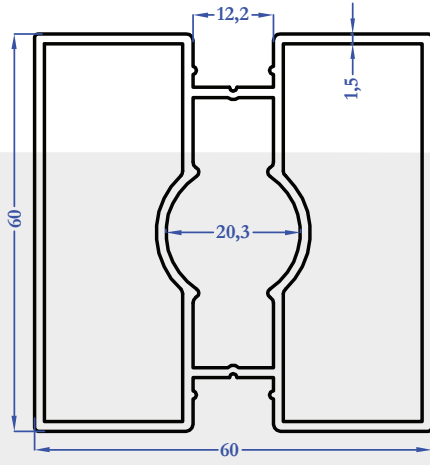

8583
1,450 kg/m

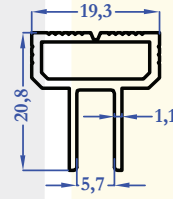

8601
0,259 kg/m

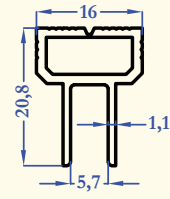

8886
0,233 kg/m

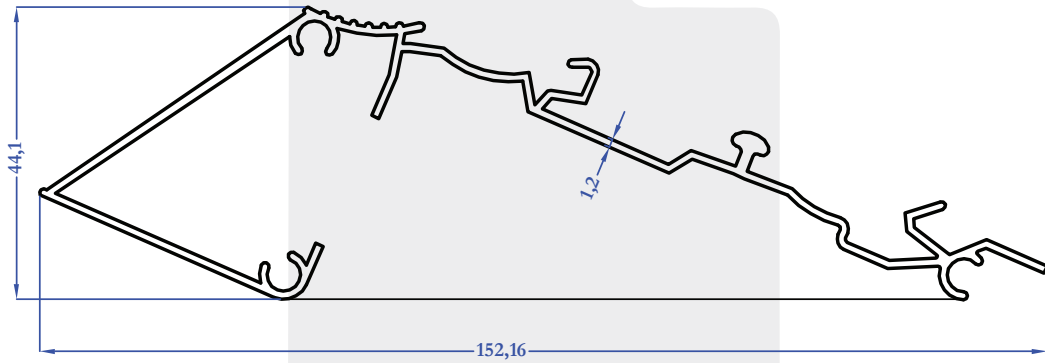

8599
1,043 kg/m

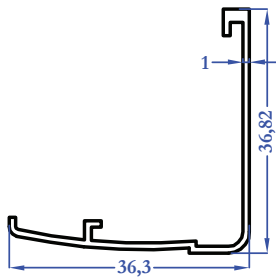

8592
0,233 kg/m

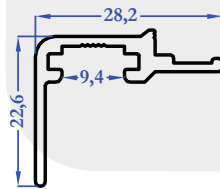

8595
0,276 kg/m

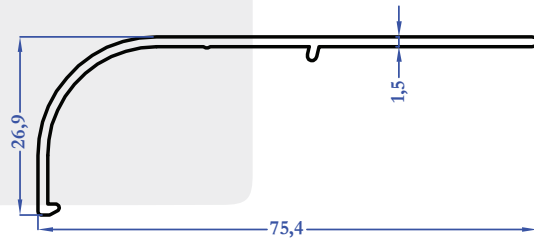

8597
0,393 kg/m

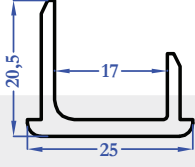

8650
0,316 kg/m

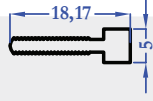

8666
0,138 kg/m



8693
0,140 kg/m

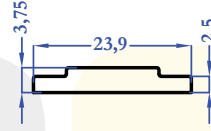

8633
0,208 kg/m

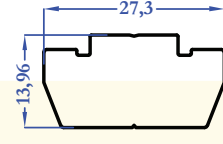

8622
0,833 kg/m

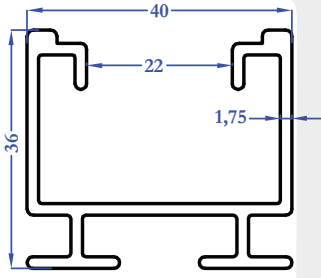

8635
0,771 kg/m

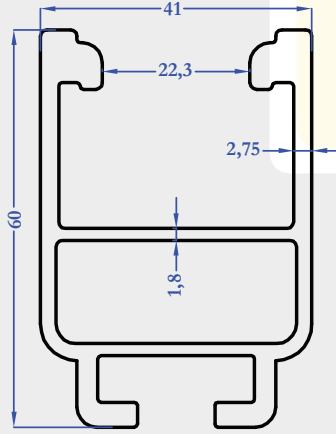

8636
1,590 kg/m

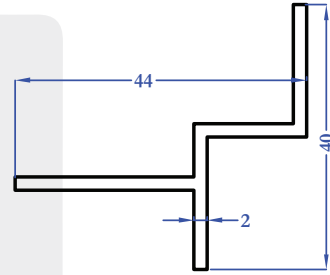

8649
0,444 kg/m

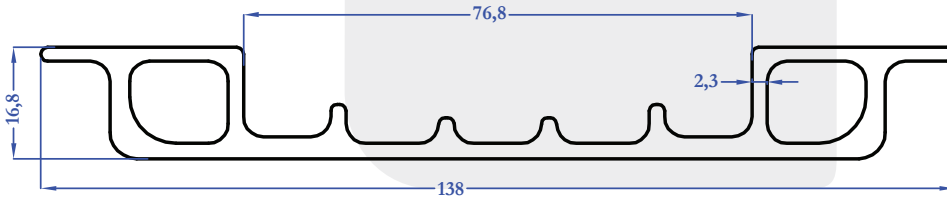

8646
1,747 kg/m

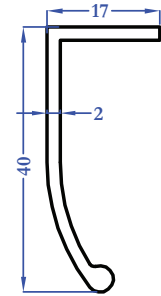

8665
0,323 kg/m

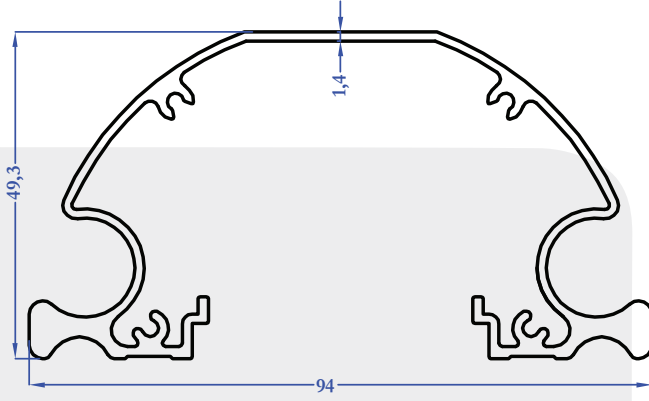

8654
1,325 kg/m

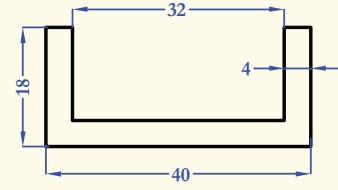

8664
0,737 kg/m

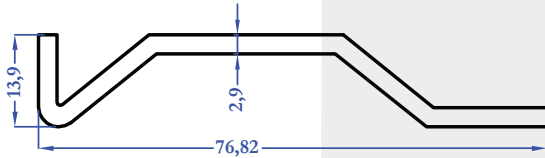

8667
0,747 kg/m

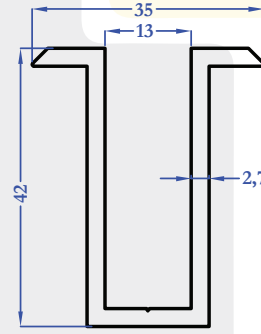

8683
0,815 kg/m

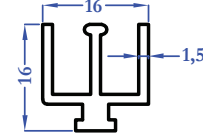

8709
0,251 kg/m

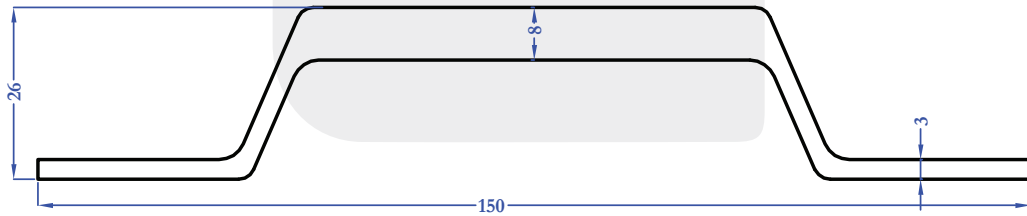

8752
2,395 kg/m

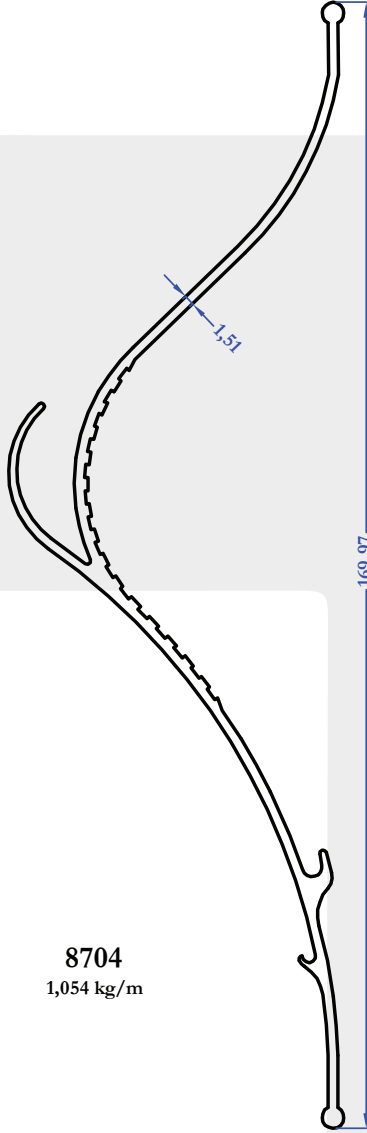

8704
1,054 kg/m

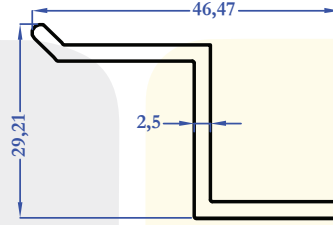

8733
0,481 kg/m

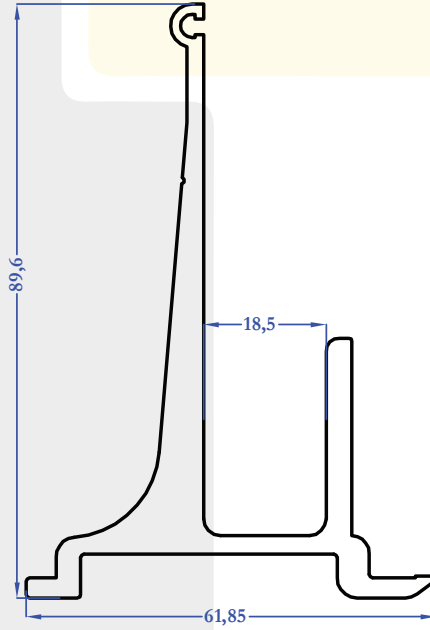

8739
2,010 kg/m

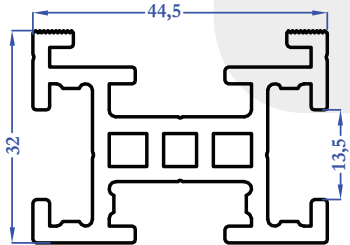

8720
1,322 kg/m

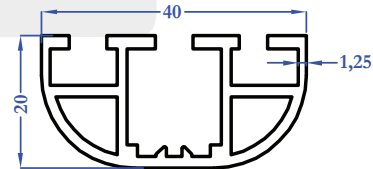

8711
0,665 kg/m

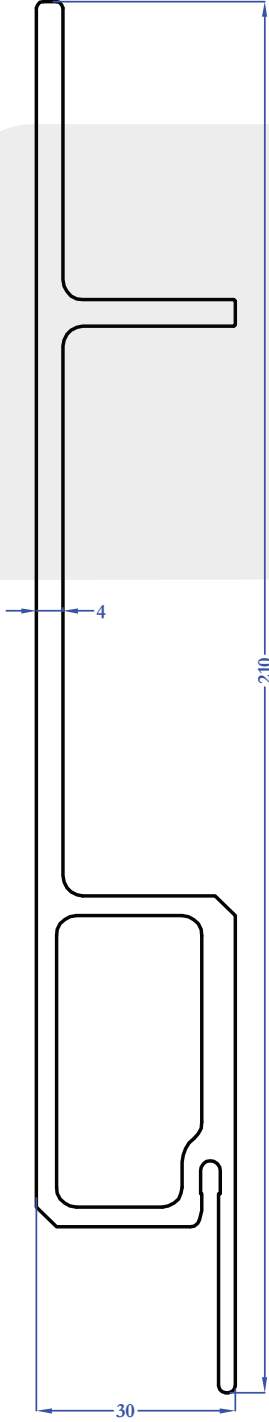

8741
3,370 kg/m

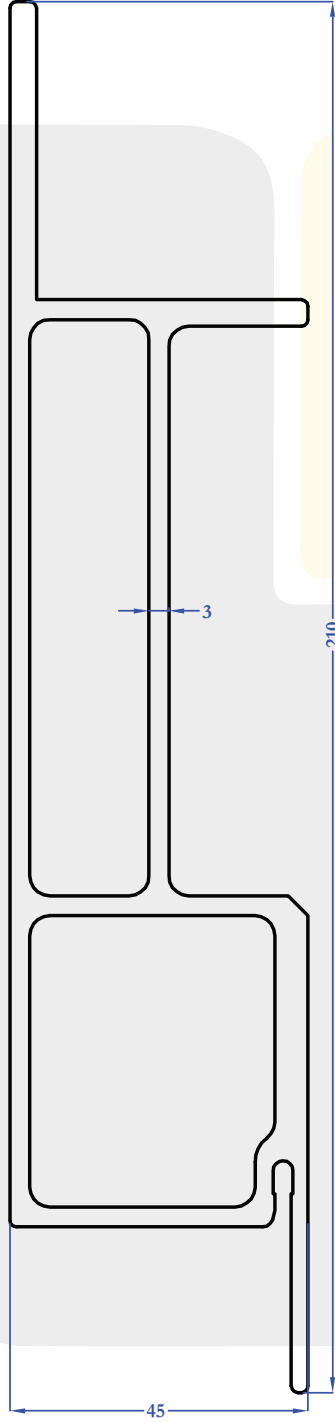

8742
4,225 kg/m

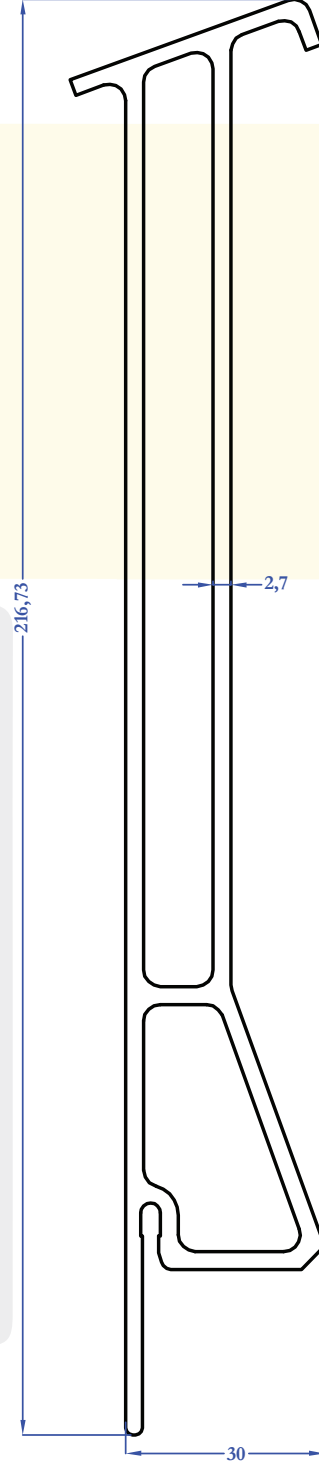

8743
3,495 kg/m

KATALOG DEĞERLERİ TEORİKTİR.

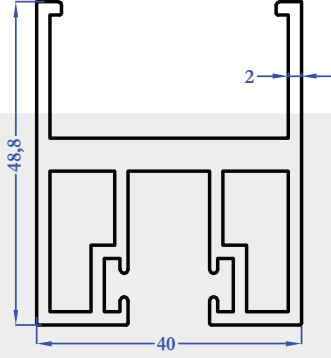

8744
1,460 kg/m

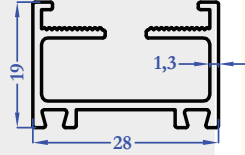

8750
0,325 kg/m

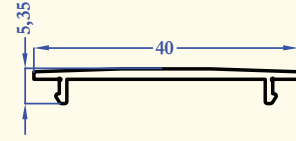

8745
0,190 kg/m

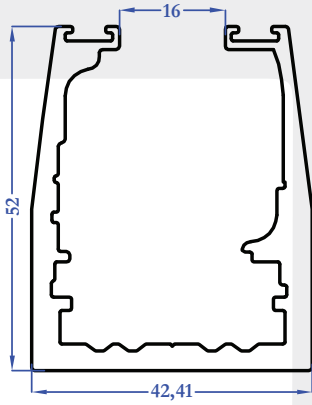

9016
1,544 kg/m

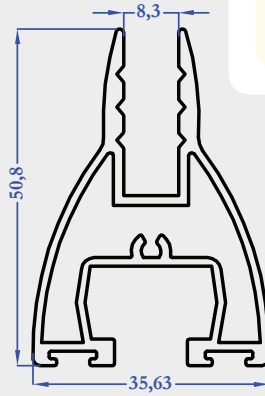

9017
0,905 kg/m

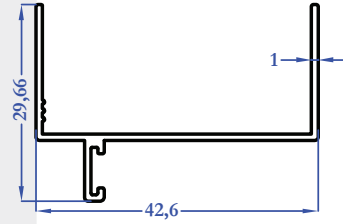

9018
0,303 kg/m

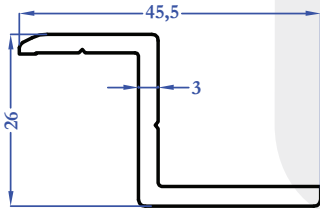

9021
0,539 kg/m

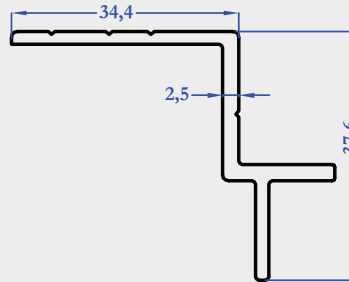

9022
0,501 kg/m

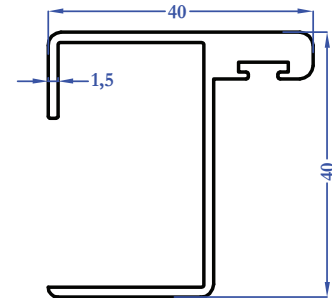

8776
0,631 kg/m

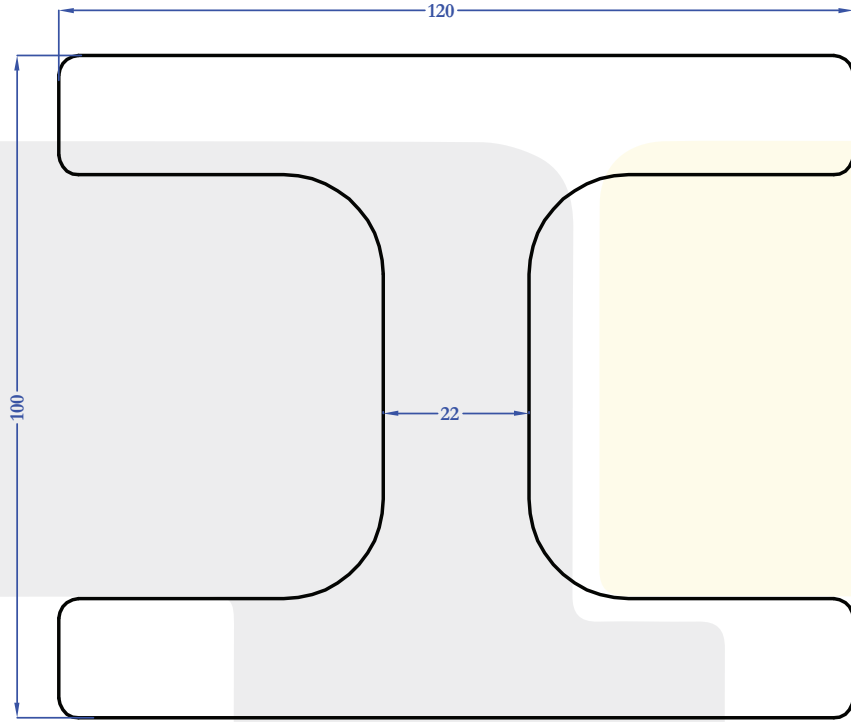

8759
16,000 kg/m



8748
1,615 kg/m

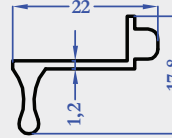

8790
0,185 kg/m

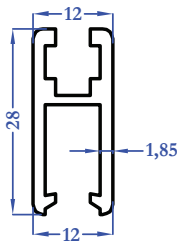

8791
0,404 kg/m

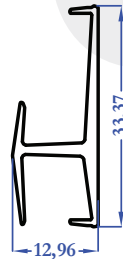

8801
0,249 kg/m

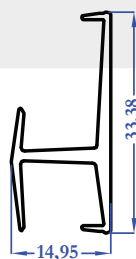

8802
0,260 kg/m

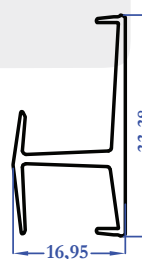

8803
0,273 kg/m

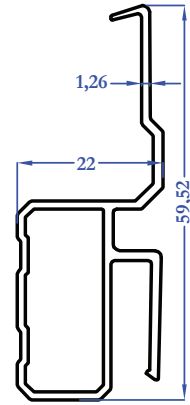

8799
0,512 kg/m

KATALOG DEĞERLERİ TEORİKTİR.

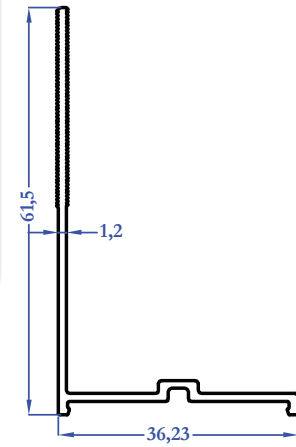
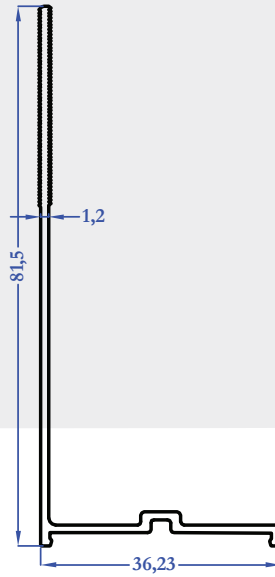
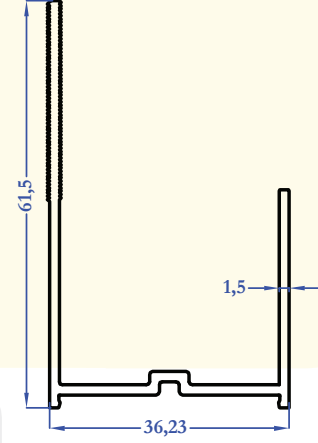
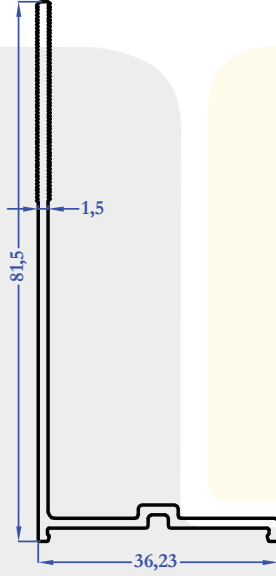
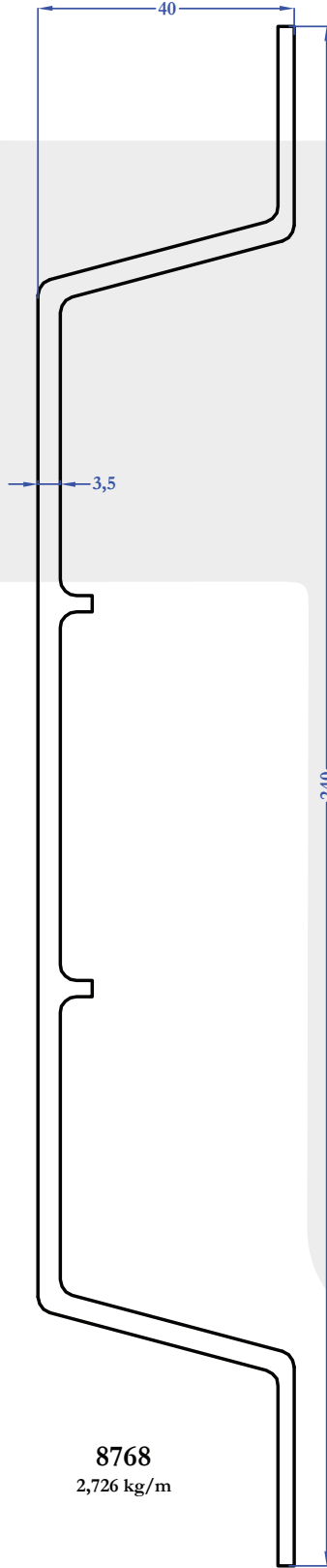

KATALOG DEĞERLERİ TEORİKTİR.

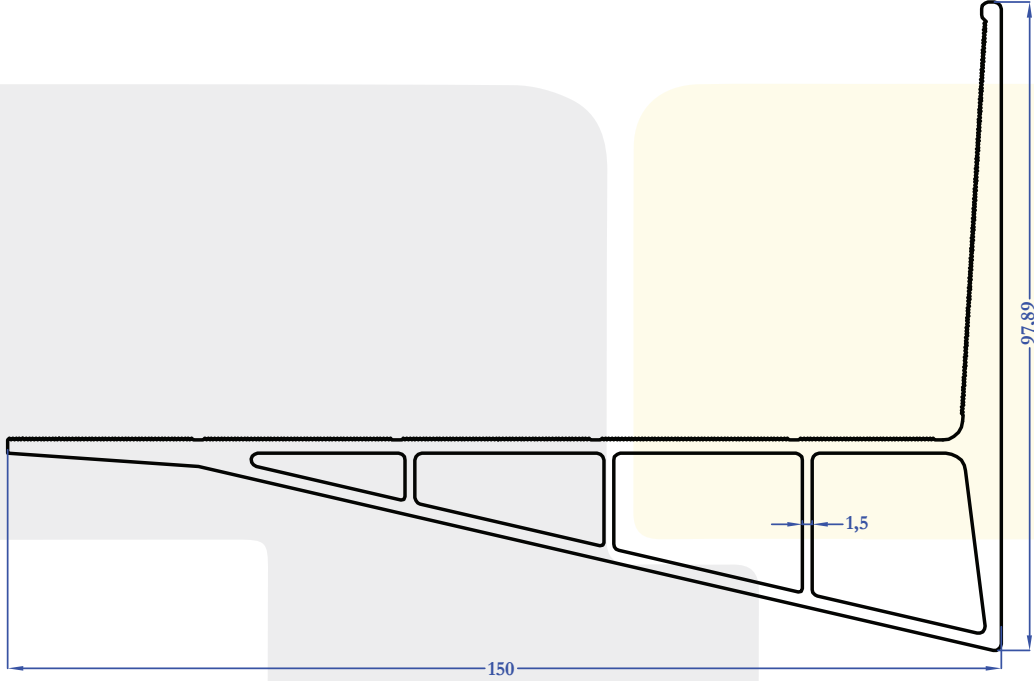

8809
2,874 kg/m

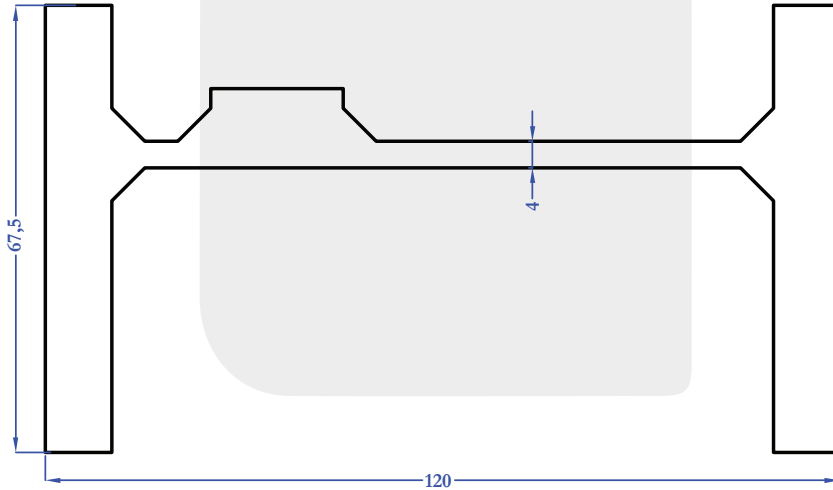

8812
5,380 kg/m

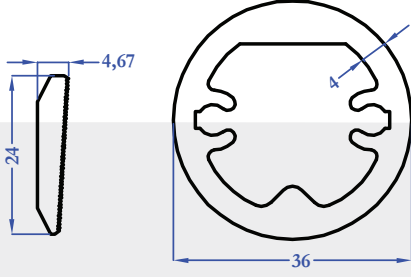

8806
0,228 kg/m

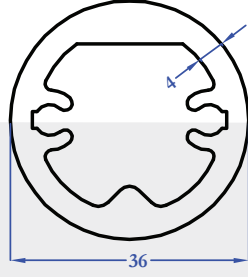

8813
1,336 kg/m

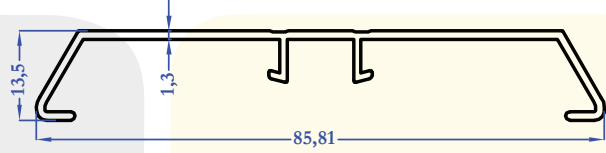

8821
0,430 kg/m

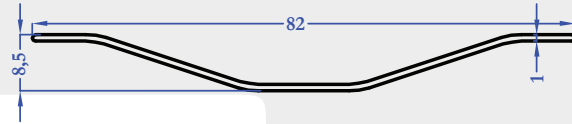

8822
0,228 kg/m

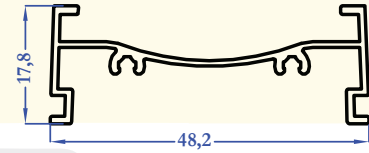

8825
0,303 kg/m

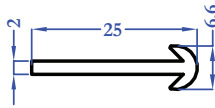

8867
0,163 kg/m

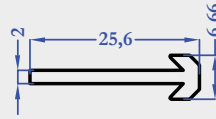

8868
0,177 kg/m

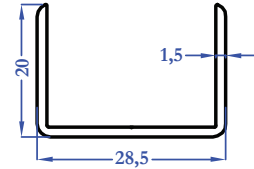

8871
0,258 kg/m

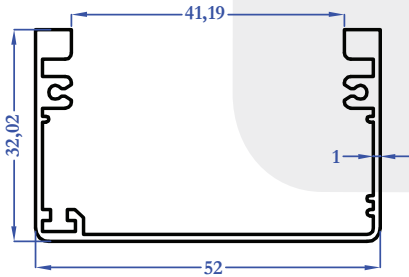

8877
0,535 kg/m

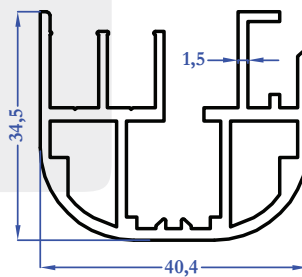

8896
0,935 kg/m

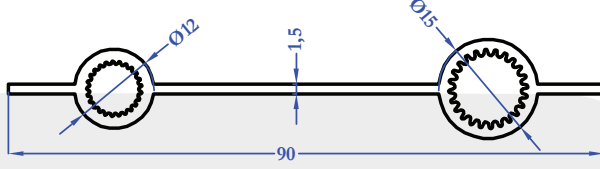

8890
0,655 kg/m

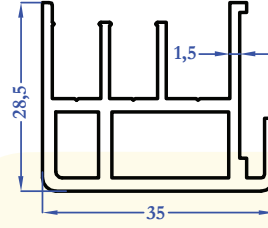

8895
0,749 kg/m

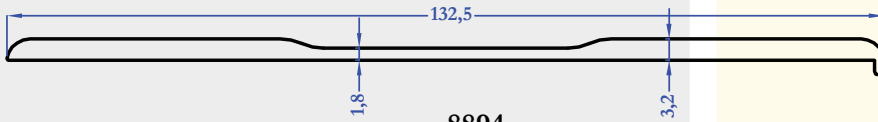

8894
0,978 kg/m

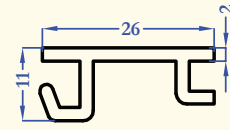

8899
0,287 kg/m

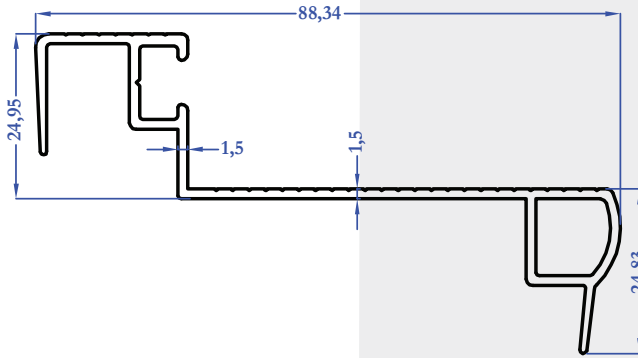

8897
0,731 kg/m

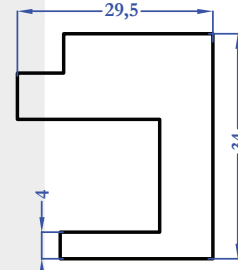

8900
1,542 kg/m

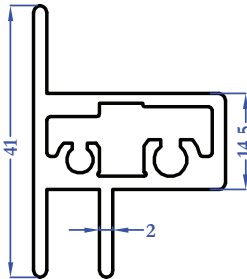

8898
0,800 kg/m

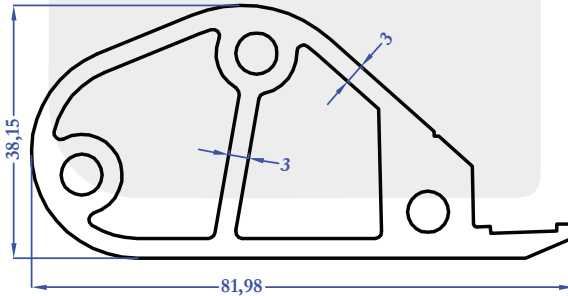

8921
2,413 kg/m

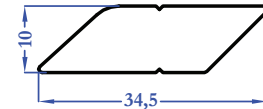

8923
0,686 kg/m

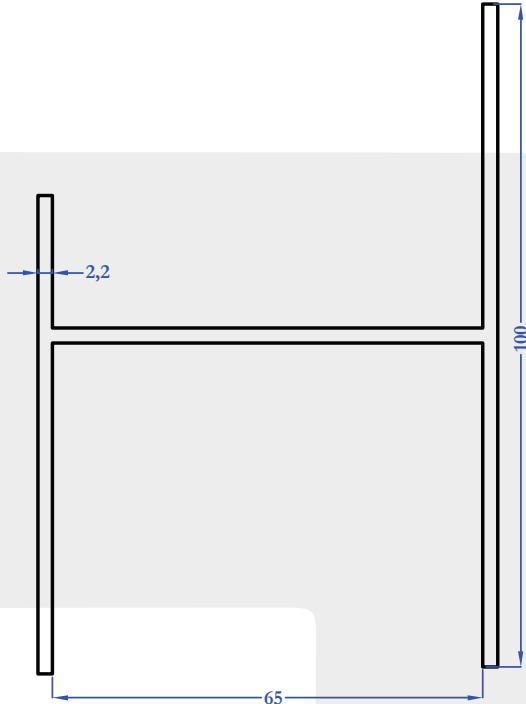

8911
1,412 kg/m

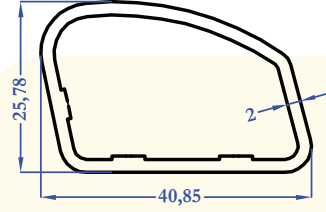

8925
0,604 kg/m

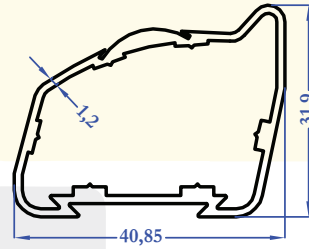

8926
0,490 kg/m

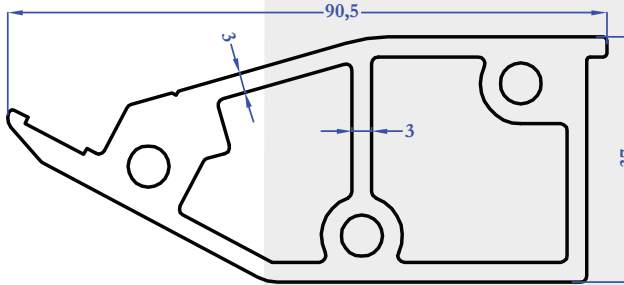

8922
2,701 kg/m

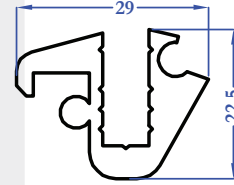

8951
0,626 kg/m

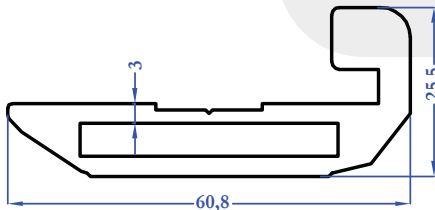

8929
1,348 kg/m

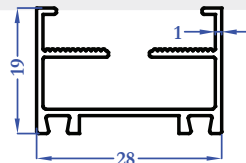

8936
0,250 kg/m

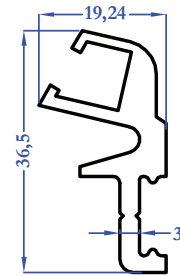

8952
0,563 kg/m

KATALOG DEĞERLERİ TEORİKTİR.

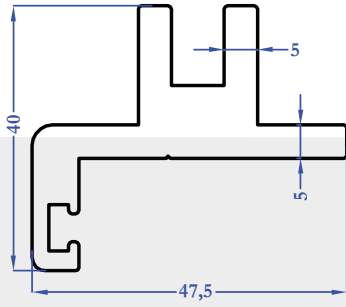

8953
1,505 kg/m

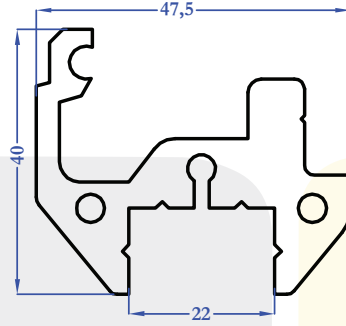

8954
1,818 kg/m

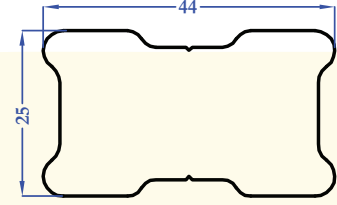

8959
2,571 kg/m

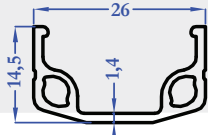

8966
0,255 kg/m

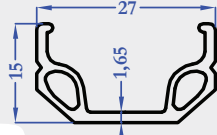

5025
0,259 kg/m

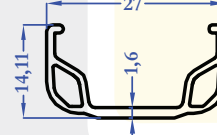

5026
0,219 kg/m

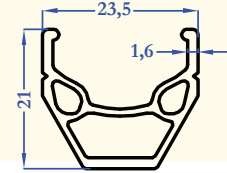

5027
0,303 kg/m

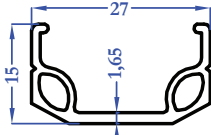

5028
0,248 kg/m

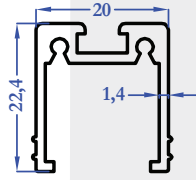

8975
0,333 kg/m

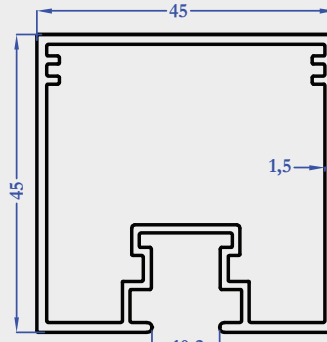

8994
0,862 kg/m

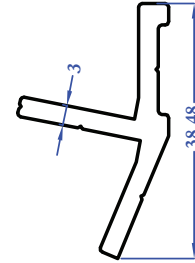

9011
0,501 kg/m

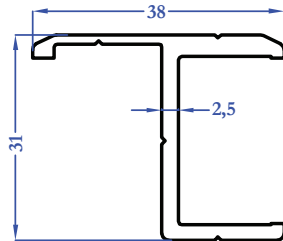

8988
0,525 kg/m

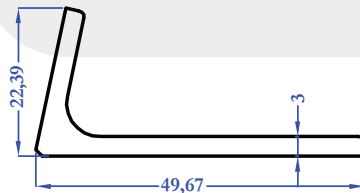

9014
0,580 kg/m

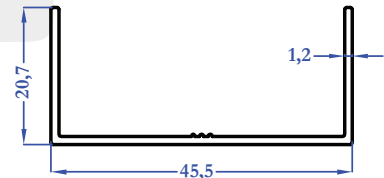

9015
0,273 kg/m

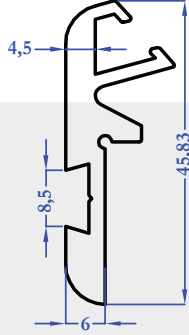

5040
0,694 kg/m

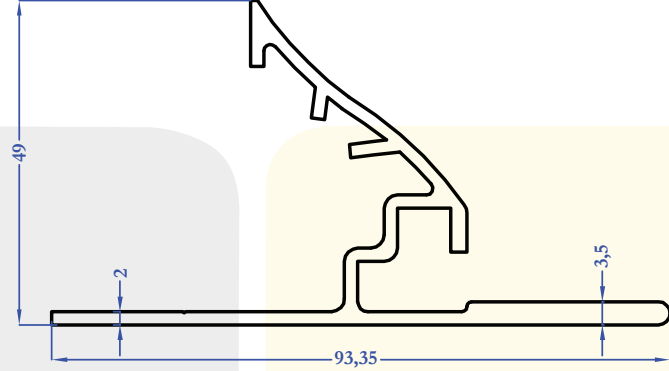

8058
1,177 kg/m

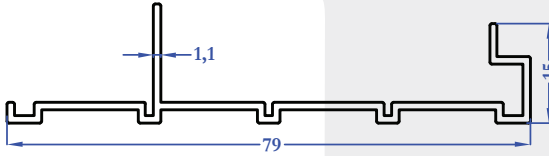

8585
0,389 kg/m

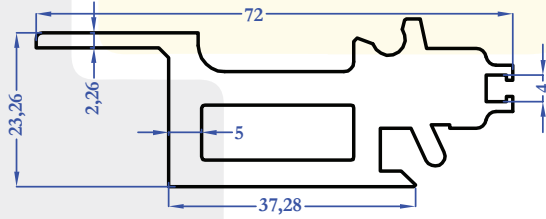

5039
1,896 kg/m

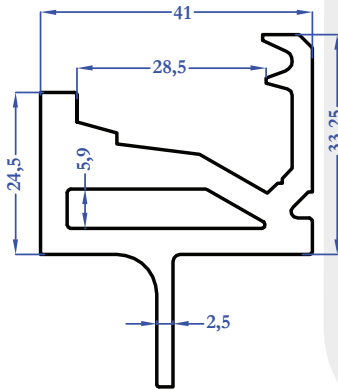

5038
1,693 kg/m

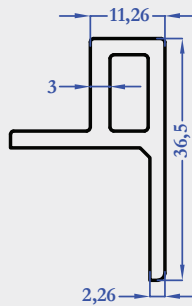

5037
0,528 kg/m

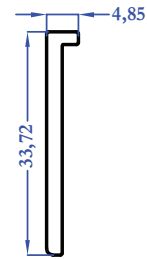

8569
0,231 kg/m

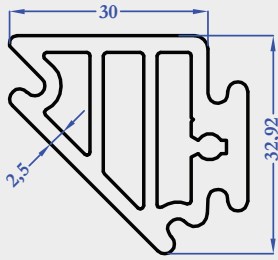

8531
1,179 kg/m

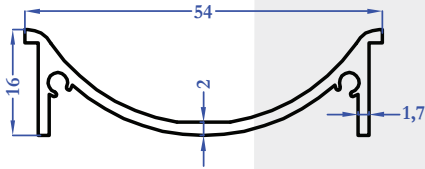

8316
0,440 kg/m

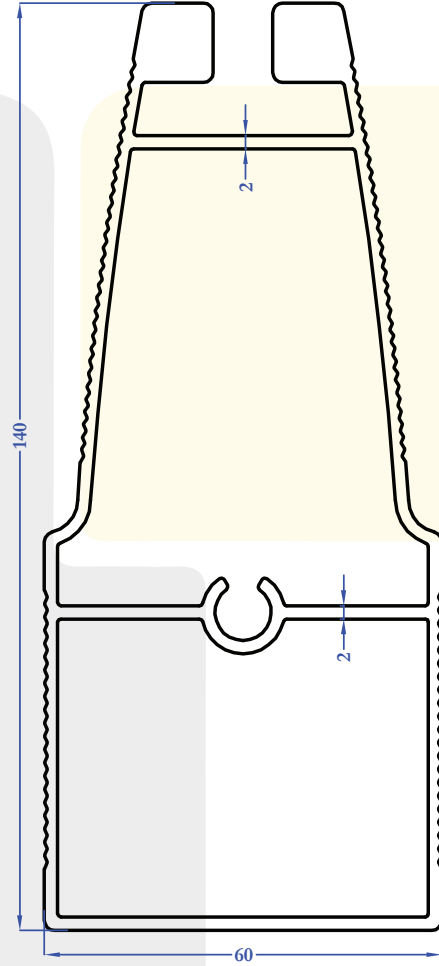

8248
2,904 kg/m

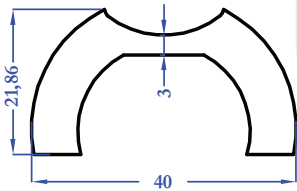

8314
0,995 kg/m

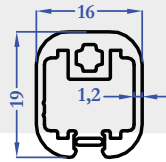

8384
0,325 kg/m

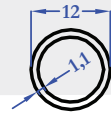

8493
0,100 kg/m

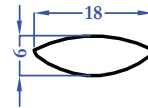

8315
0,207 kg/m

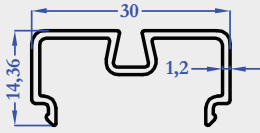

8392
0,275 kg/m

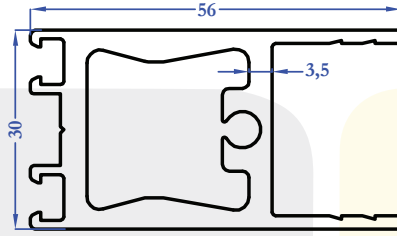

8393
1,453 kg/m

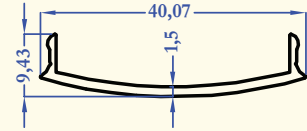

8410
0,192 kg/m

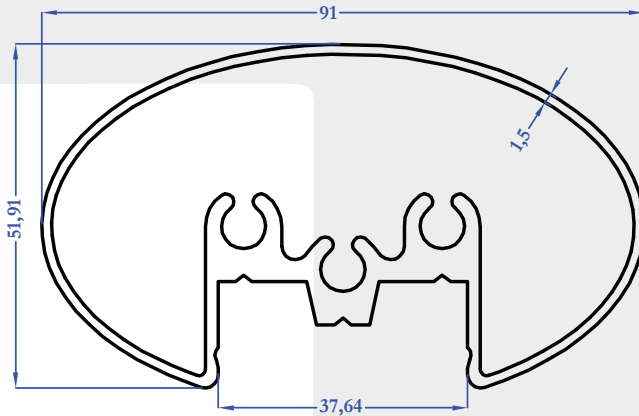

8401
1,787 kg/m

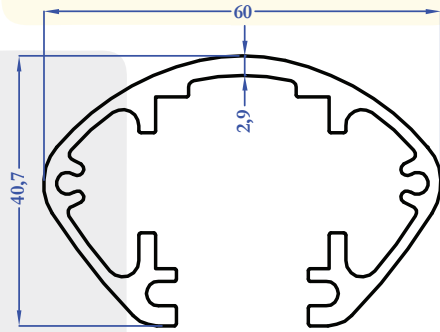

8423
1,220 kg/m

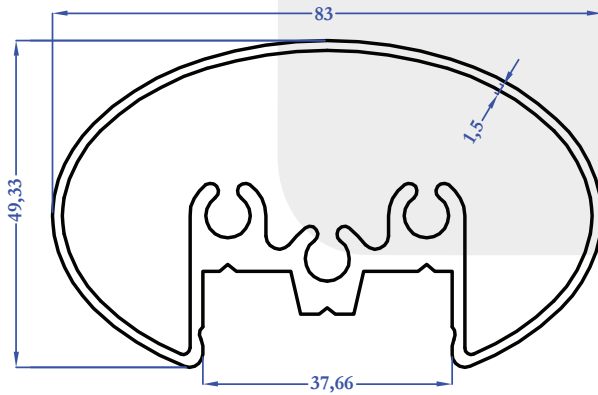

8420
1,703 kg/m

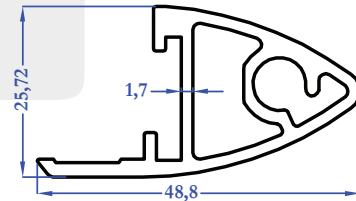

8422
0,755 kg/m

KATALOG DEĞERLERİ TEORİKTİR.

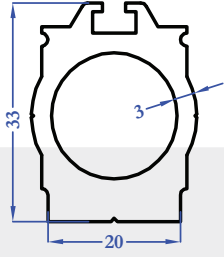

8426
1,055 kg/m

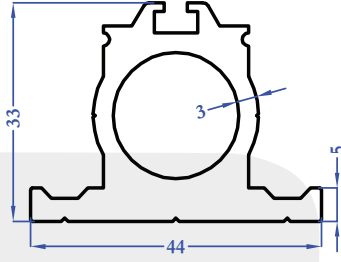

8427
1,333 kg/m

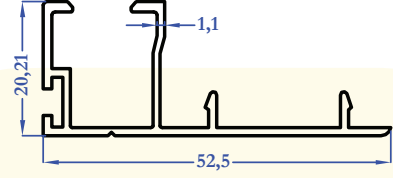

8453
0,313 kg/m

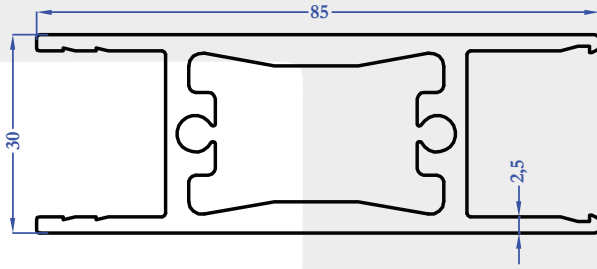

8175
2,067 kg/m

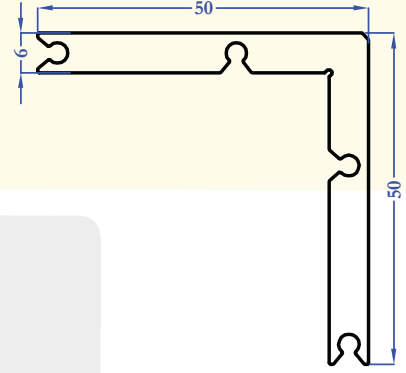

8445
1,384 kg/m

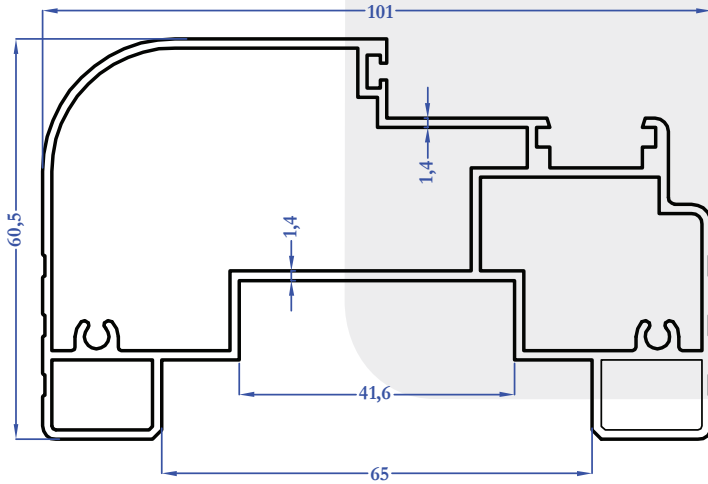

8458
1,724 kg/m

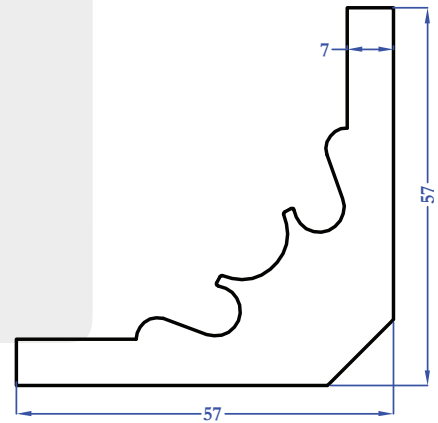

8574
2,556 kg/m

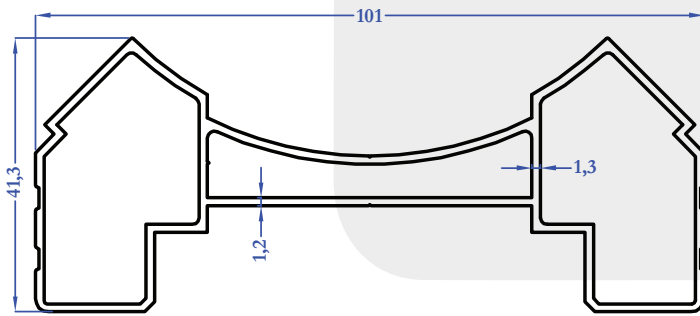
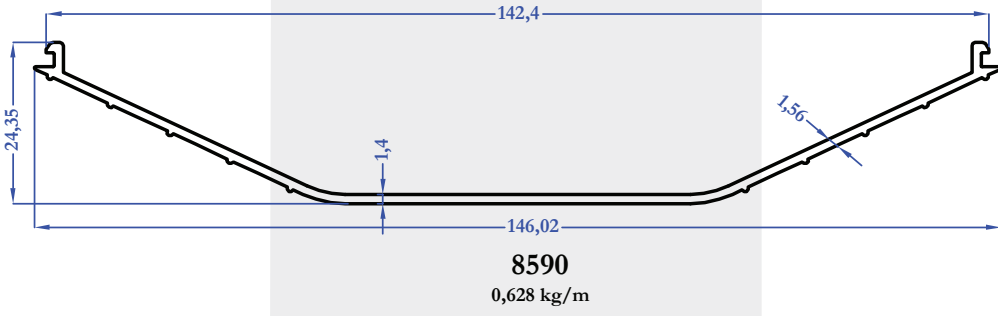
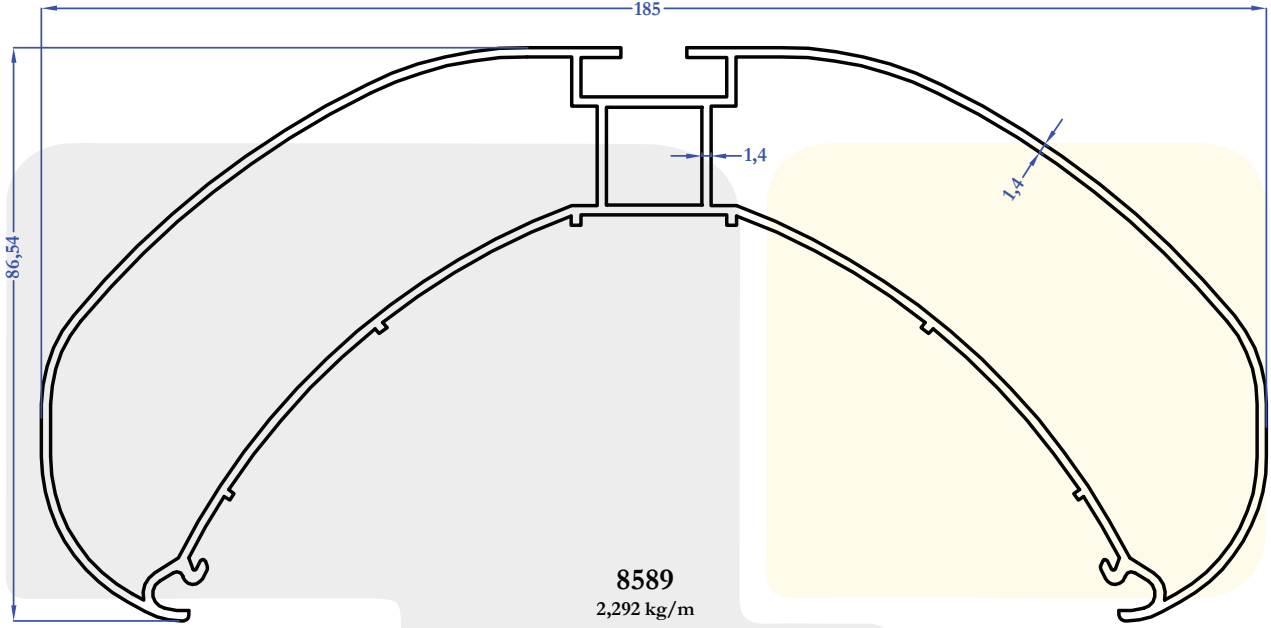

8460
1,134 kg/m

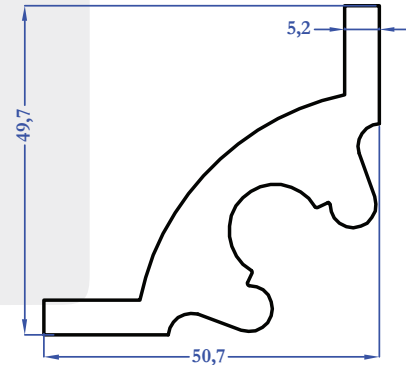

8573
1,753 kg/m

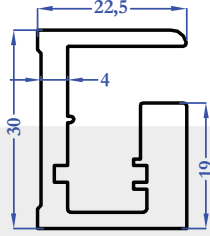

8640
0,826 kg/m

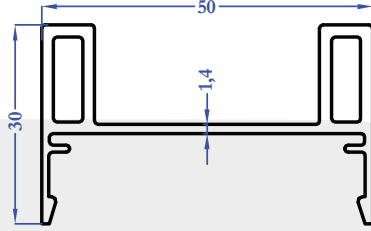

8641
0,650 kg/m

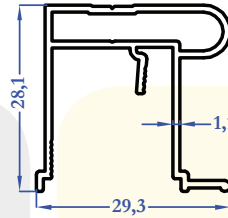

8657
0,365 kg/m

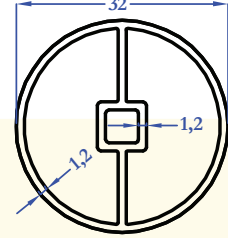

8678
0,466 kg/m

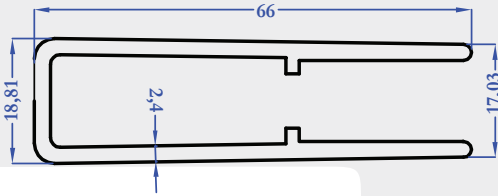

8668
0,280 kg/m

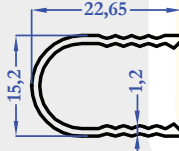

8672
0,170 kg/m

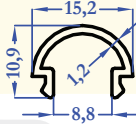

8673
0,105 kg/m

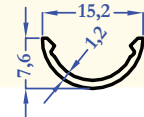

8676
0,070 kg/m

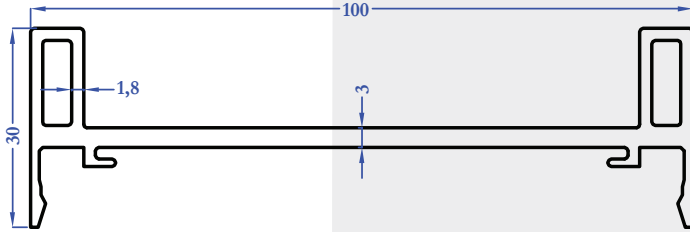

8686
1,303 kg/m

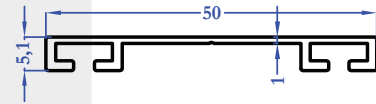

8659
0,244 kg/m

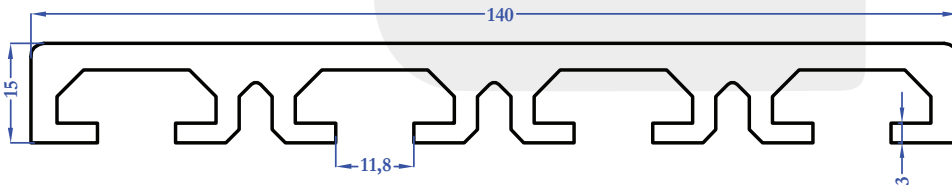

8715
3,030 kg/m

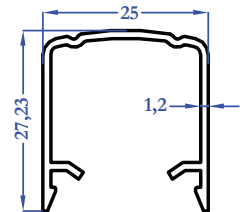

8719
0,276 kg/m

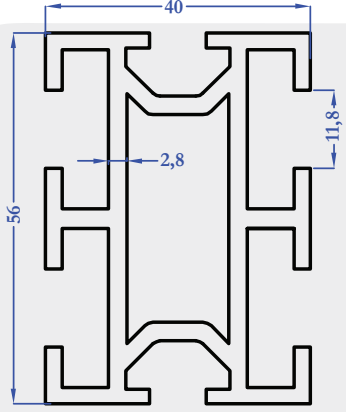

8716
1,950 kg/m

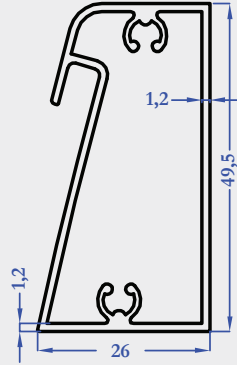

8732
0,582 kg/m

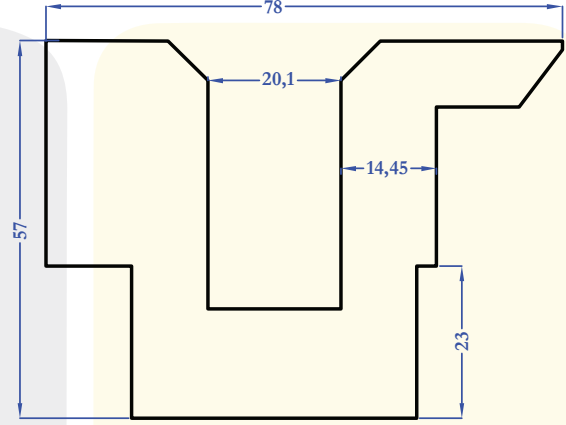

8837
6,250 kg/m

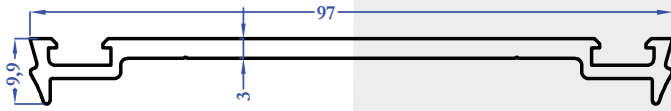

8687
0,840 kg/m

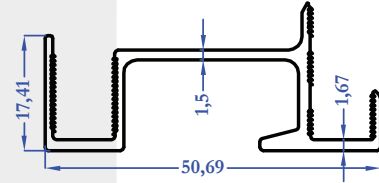

8763
0,466 kg/m

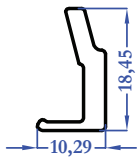

8764
0,189 kg/m

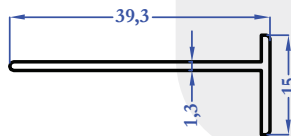

8914
0,0184 kg/m

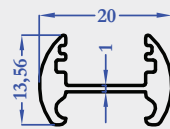

8777
0,220 kg/m

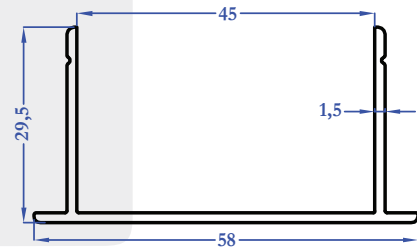

8761
0,458 kg/m

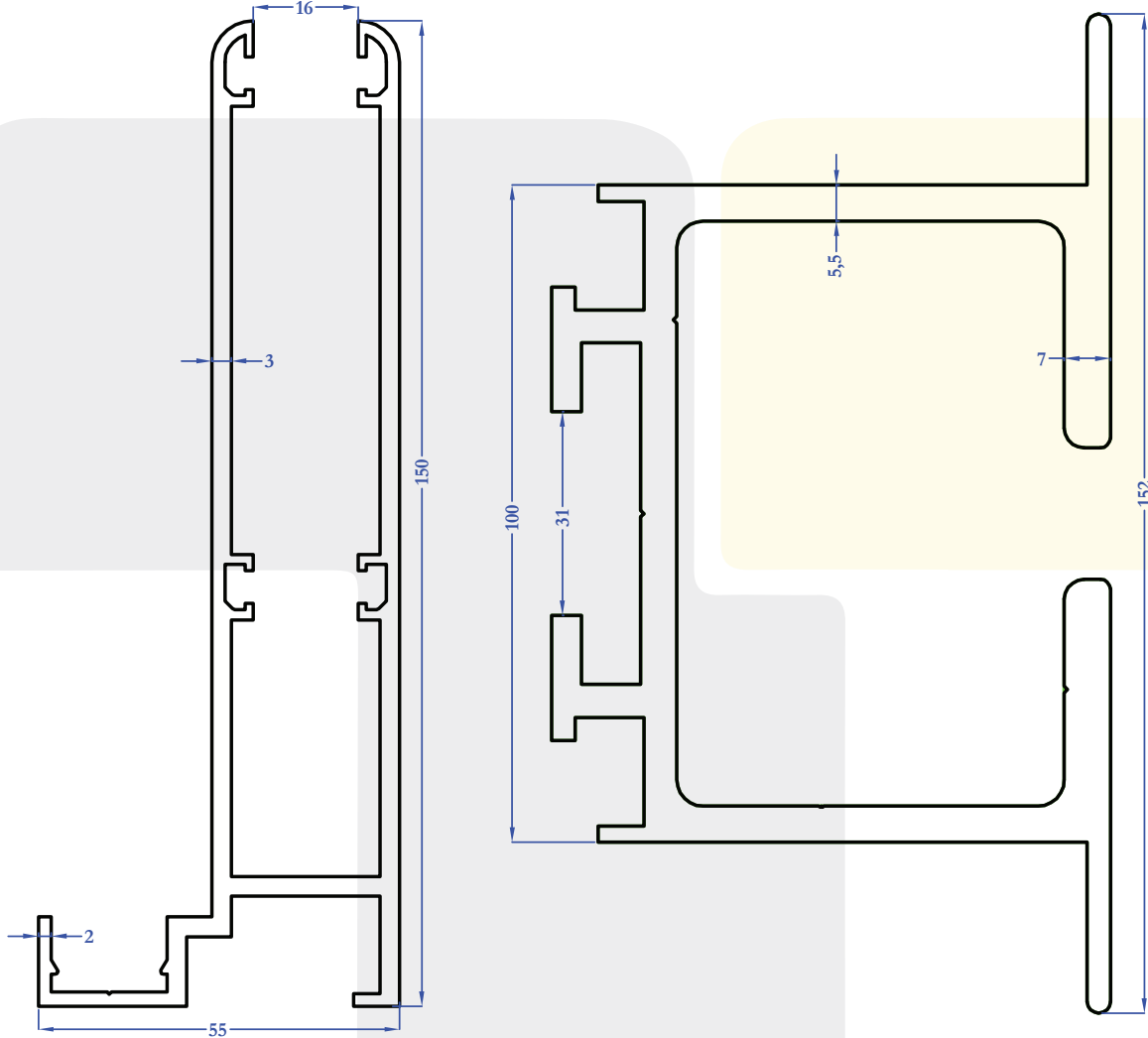

8765
2,940 kg/m

8955
6,000 kg/m

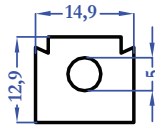

8753
0,445 kg/m

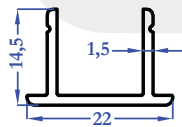

8762
0,190 kg/m

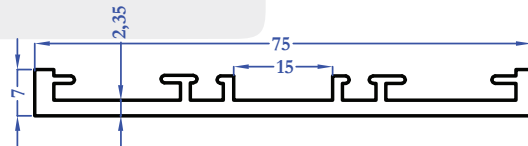

9070
0,650 kg/m

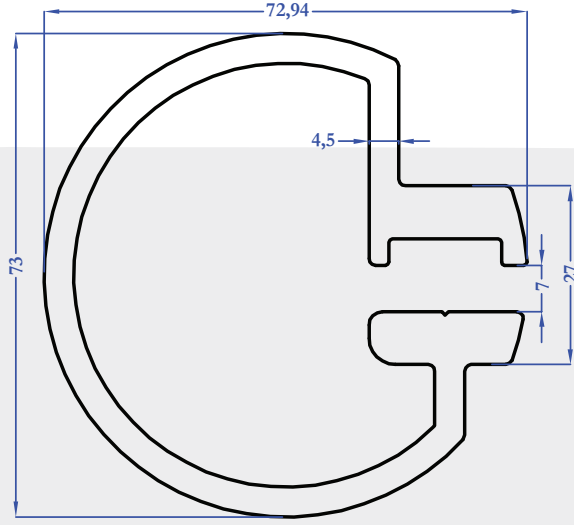

9060
3,211 kg/m

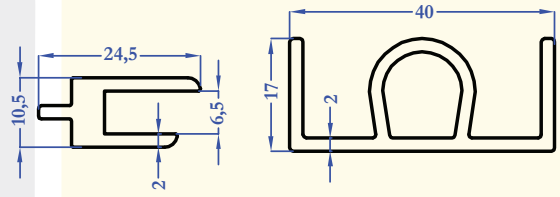

9096
0,303 kg/m

9102
0,576 kg/m

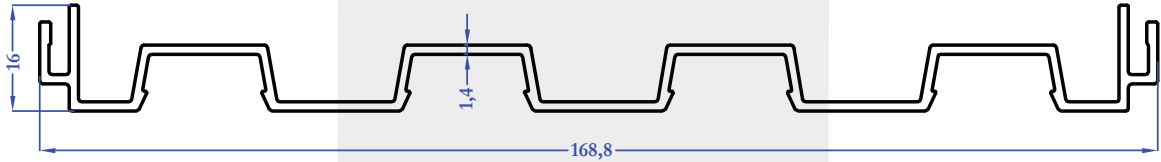

9101
1,057 kg/m

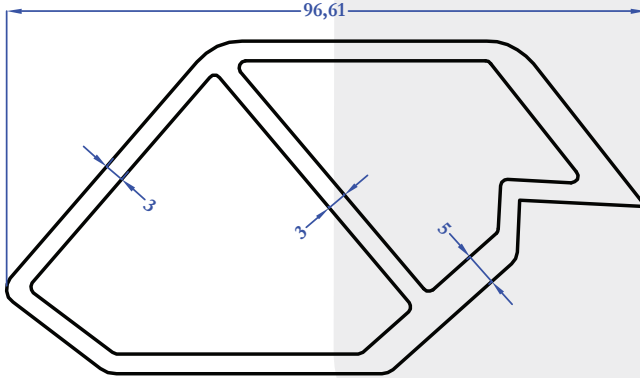

9104
2,514 kg/m

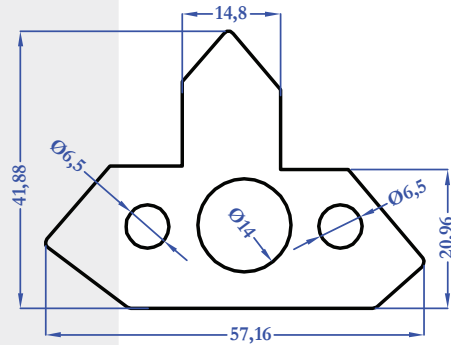

9103
2,780 kg/m

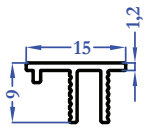

9106
0,100 kg/m

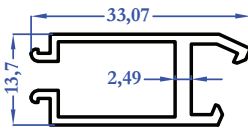

9108
0,320 kg/m

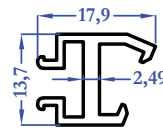

9109
0,219 kg/m

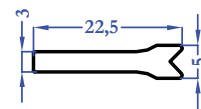

8751
0,195 kg/m

KATALOG DEĞERLERİ TEORİKTİR.

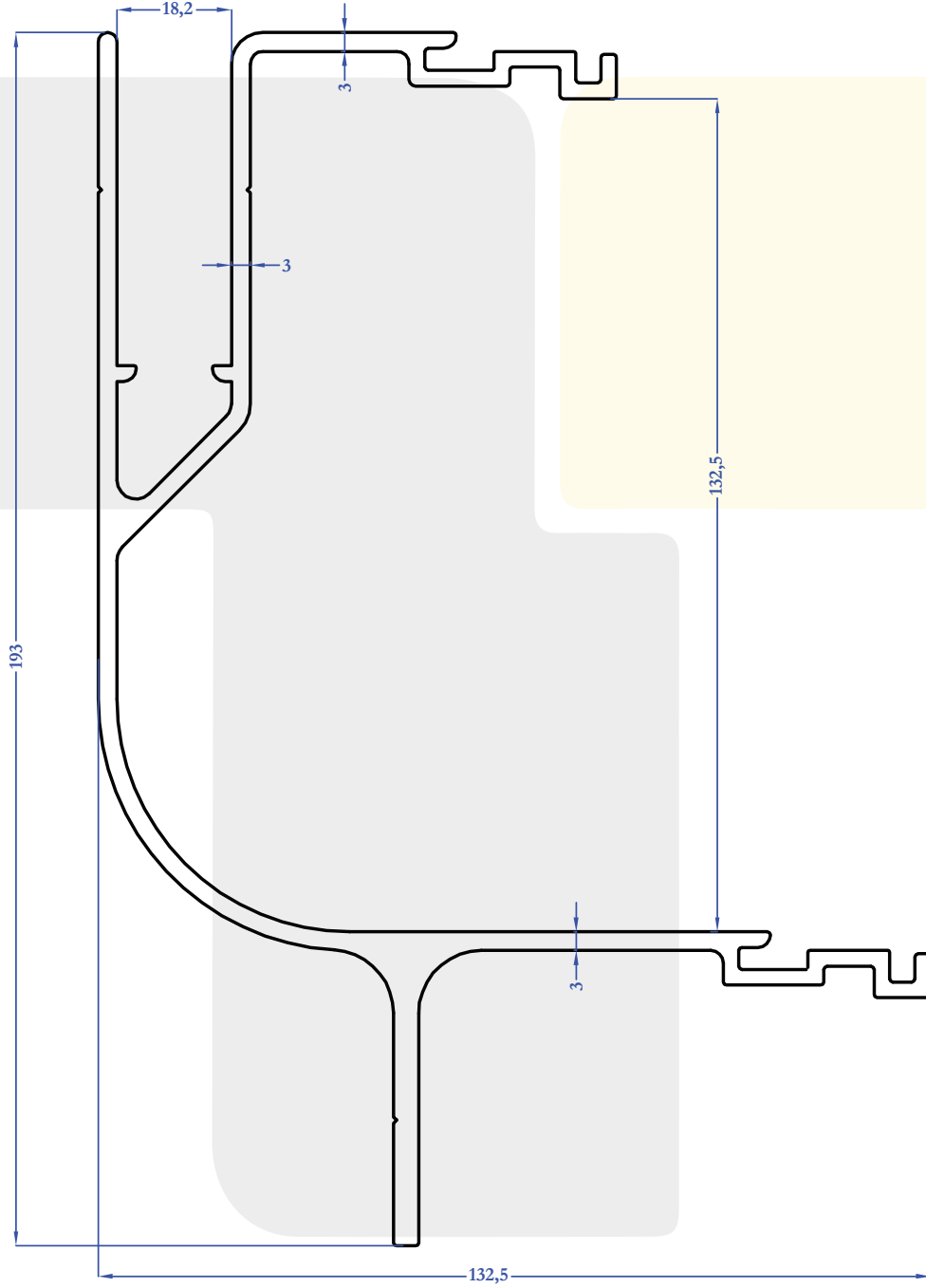

9089
4,201 kg/m

KATALOG DEĞERLERİ TEORİKTİR.

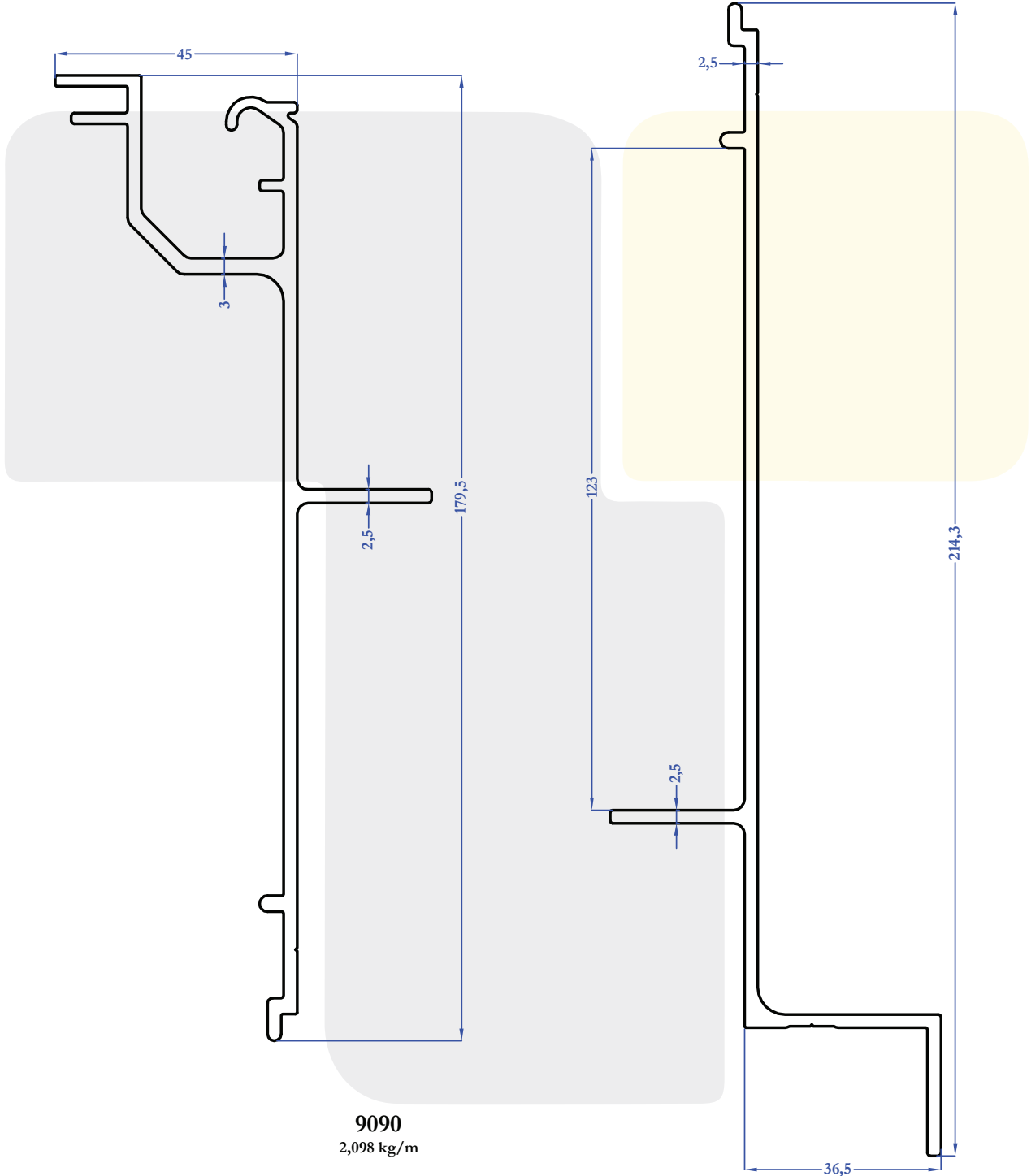

9090
2,098 kg/m

9091
1,918 kg/m

KATALOG DEĞERLERİ TEORİKTİR.

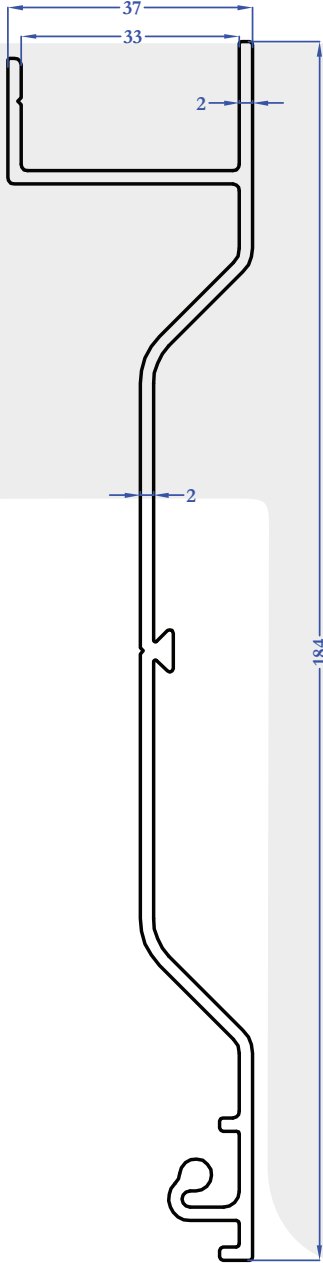

9095
1,537 kg/m

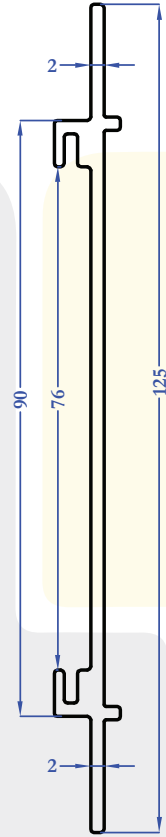

9092
0,858 kg/m

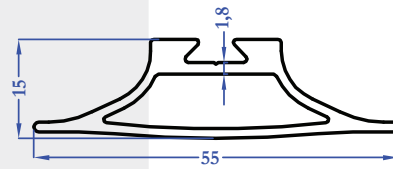

9093
0,554 kg/m

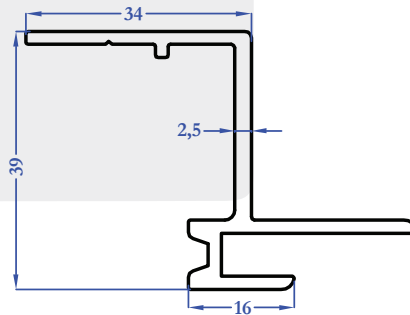

9094
0,696 kg/m

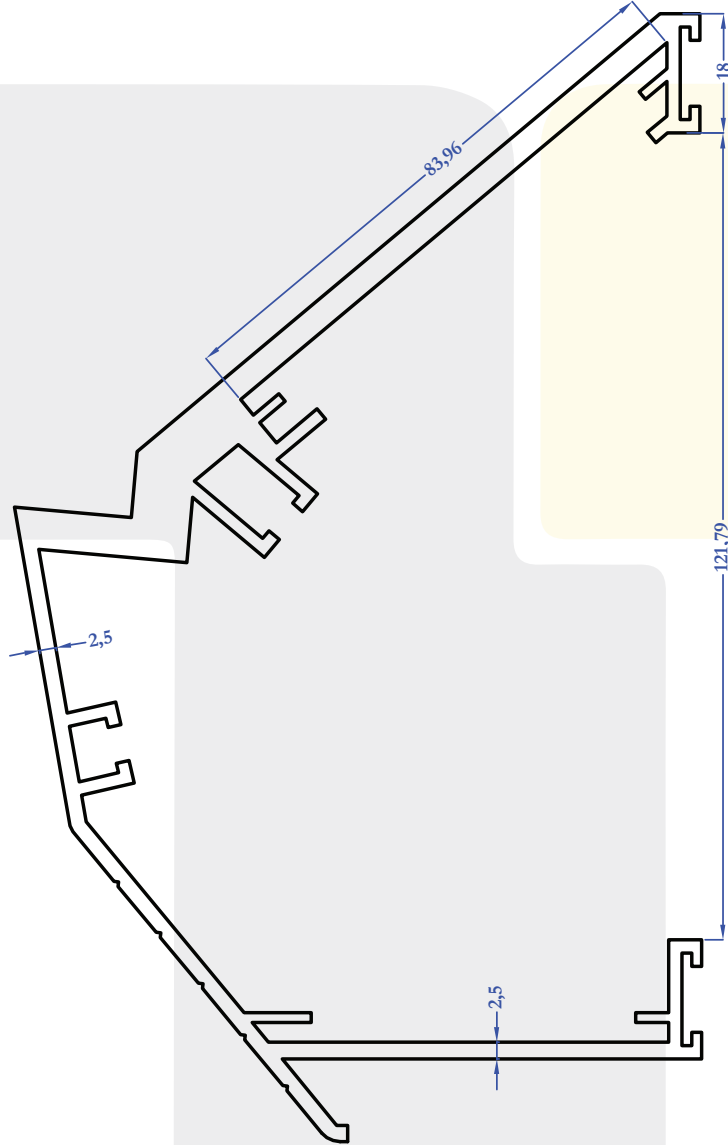

9105
3,779 kg/m

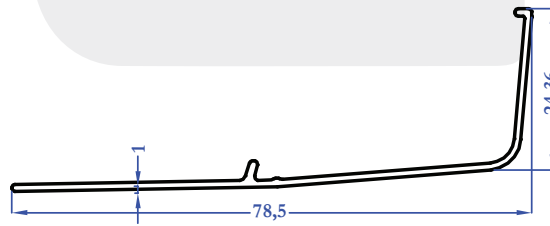

9135
0,283 kg/m

KATALOG DEĞERLERİ TEORİKTİR.

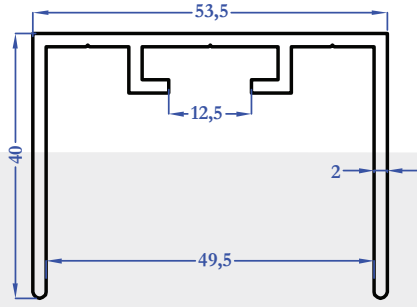

9122
0,283 kg/m

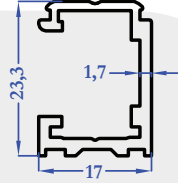

9132
0,295 kg/m

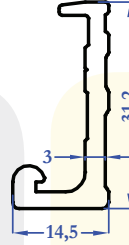

9133
0,396 kg/m

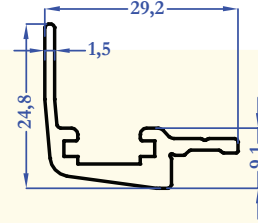

9134
0,349 kg/m

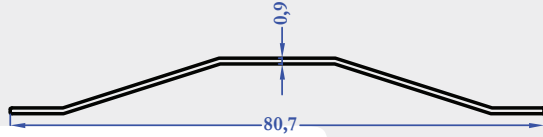

9115
0,202 kg/m

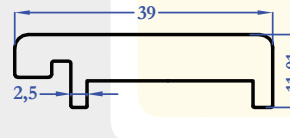

9167
0,765 kg/m

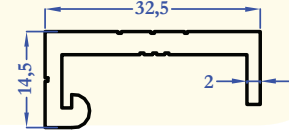

9160
0,460 kg/m

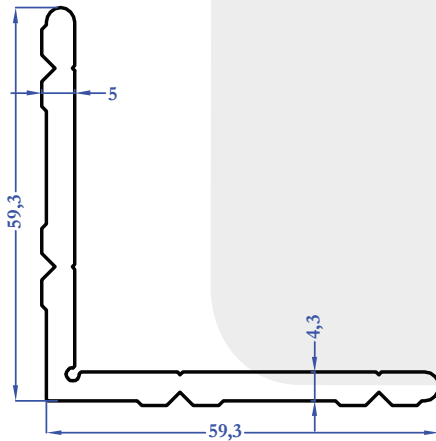

9168
1,362 kg/m

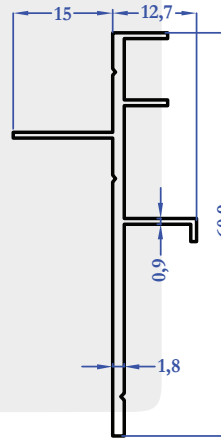

9201
0,395 kg/m

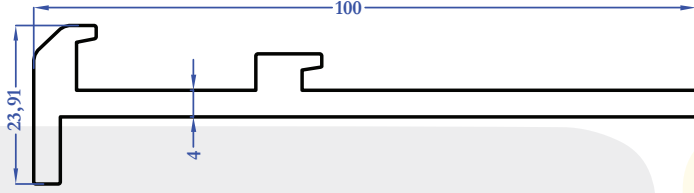

9166
1,478 kg/m

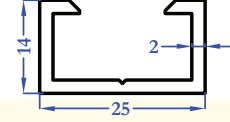

9170
0,302 kg/m

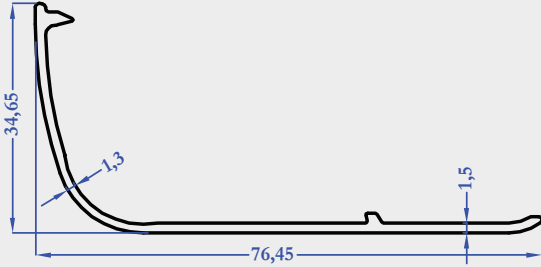

9198
0,430 kg/m

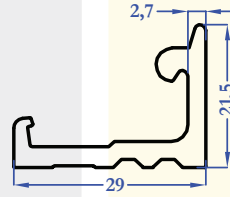

9196
0,452 kg/m

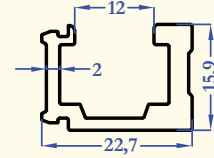

9197
0,361 kg/m

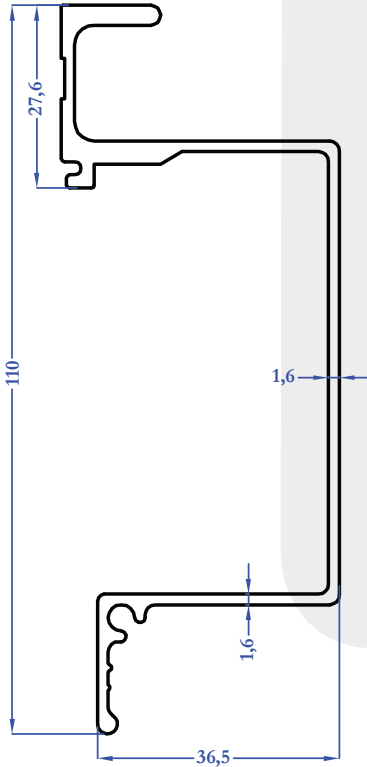

9188
1,086 kg/m

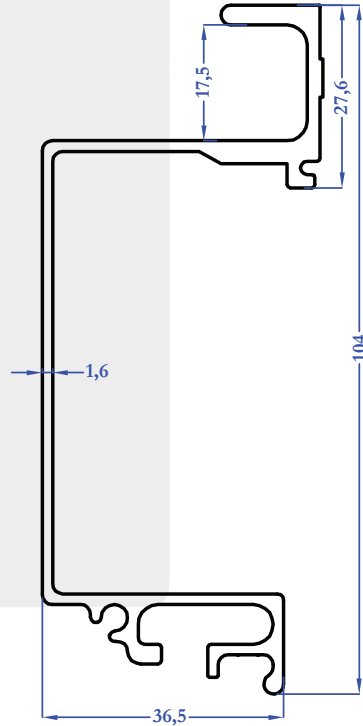

9187
1,214 kg/m

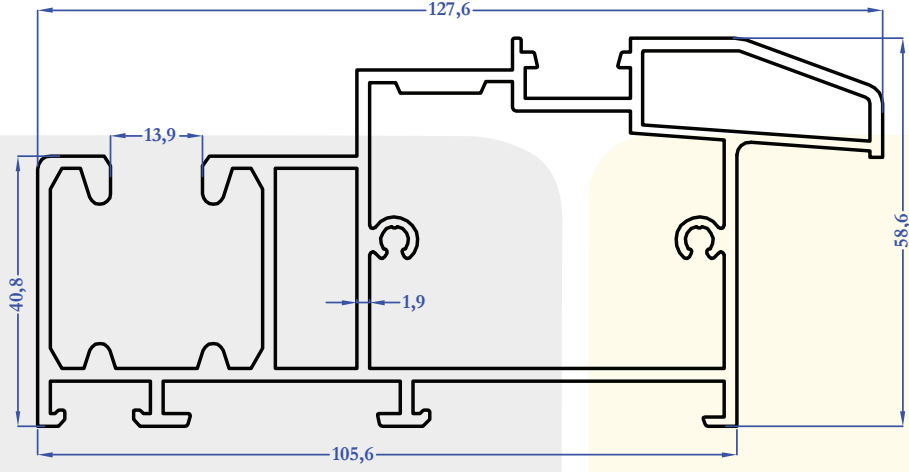

9207
2,750 kg/m

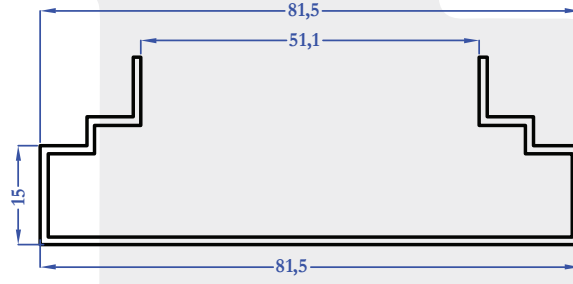

9210
0,540 kg/m

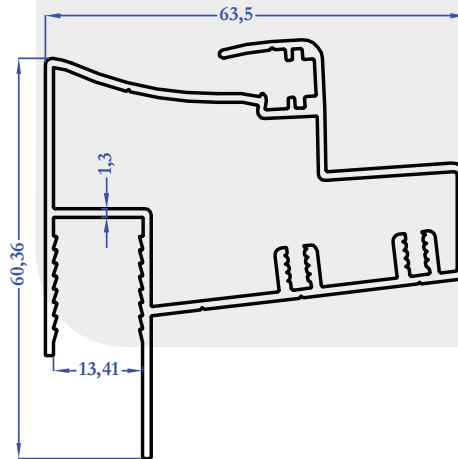

9214
1,059 kg/m

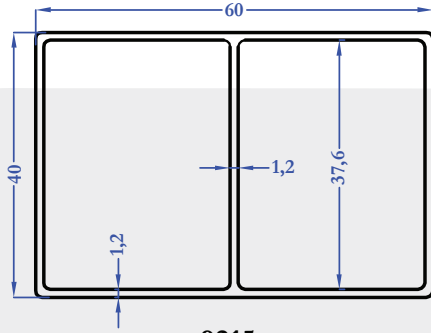

9215
0,758 kg/m

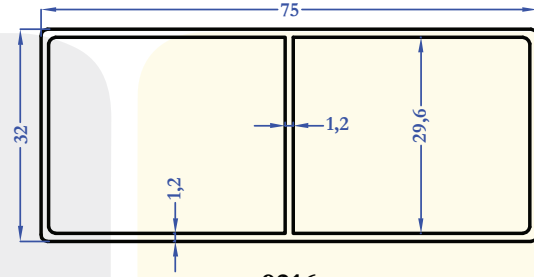

9216
0,777 kg/m

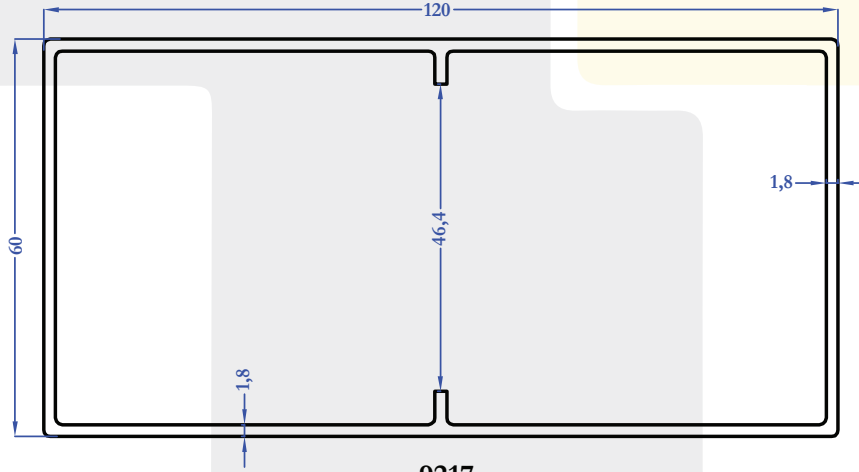

9217
1,772 kg/m

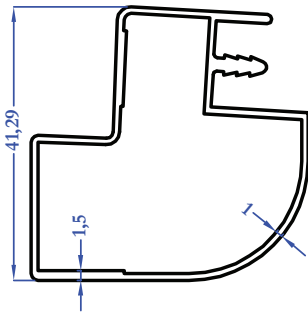

9218
0,527 kg/m

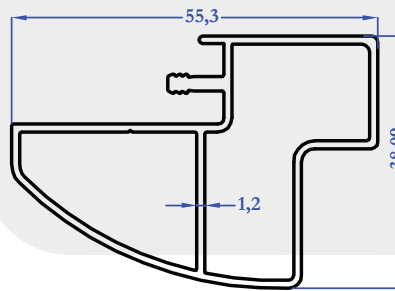

9219
0,677 kg/m

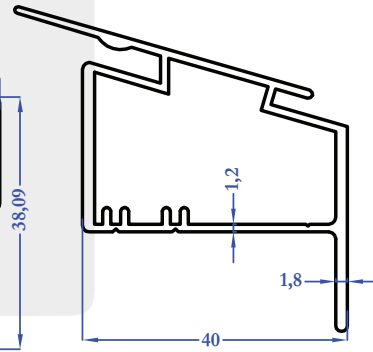

9220
0,676 kg/m

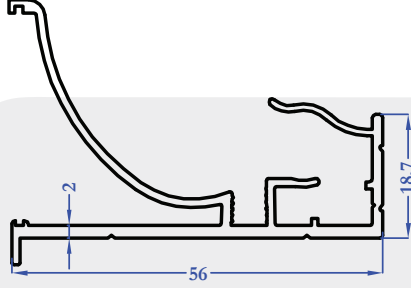

9221
0,681 kg/m

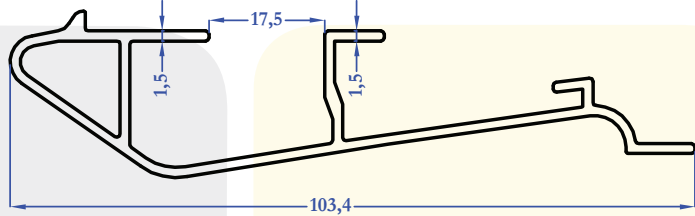

9223
0,807 kg/m

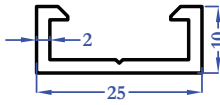

9222
0,245 kg/m

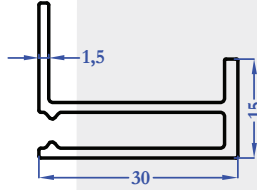

9227
0,379 kg/m

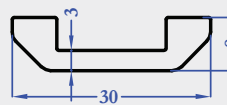

9233
0,358 kg/m

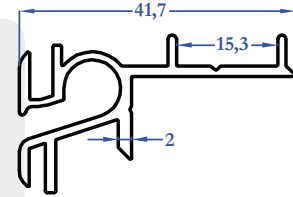

9234
0,428 kg/m

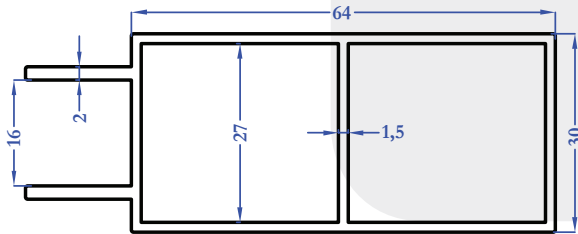

9228
1,023 kg/m

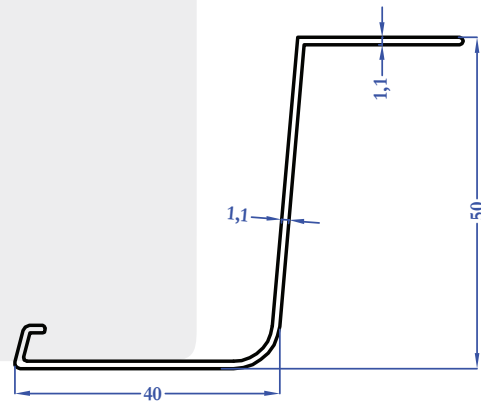

9238
0,352 kg/m

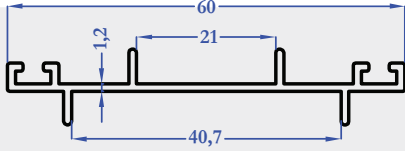

M5346
0,315 kg/m

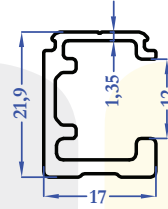

9253
0,331 kg/m

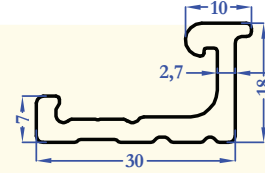

9252
0,485 kg/m

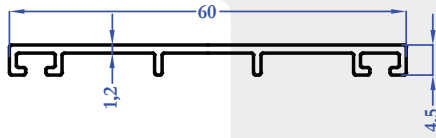

M5668
0,271 kg/m

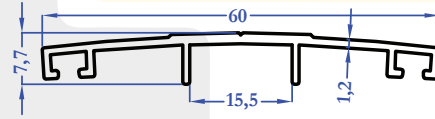

M5345
0,312 kg/m

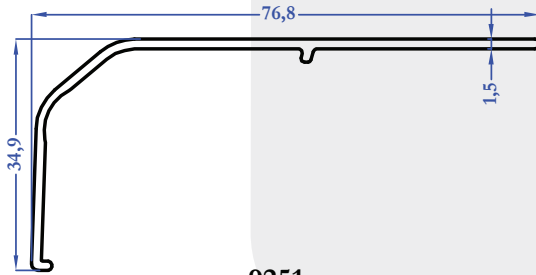

9251
0,425 kg/m

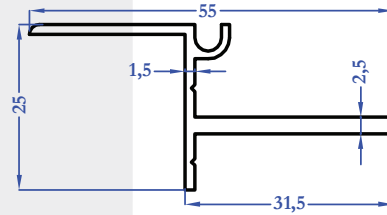

9261
0,425 kg/m

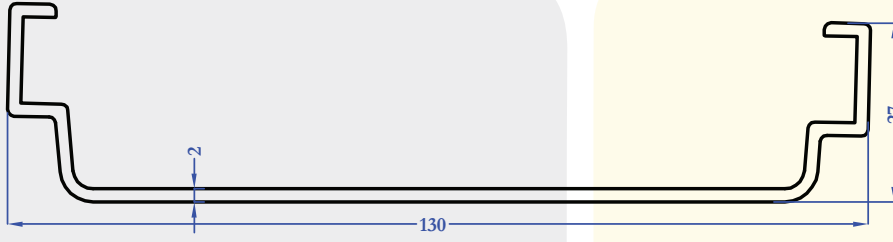

9250
1,016 kg/m

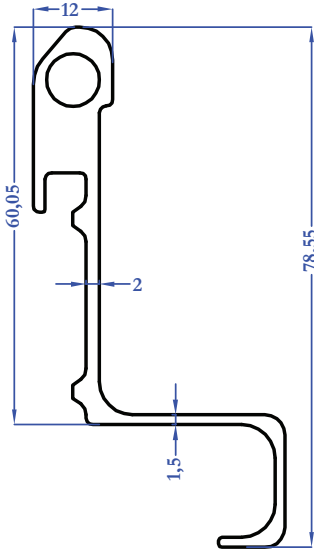

9270
0,990 kg/m

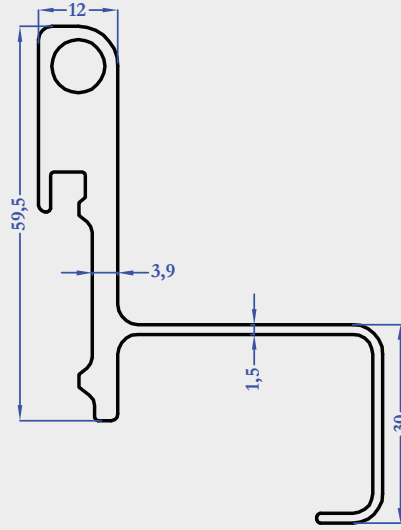

9271
1,335 kg/m

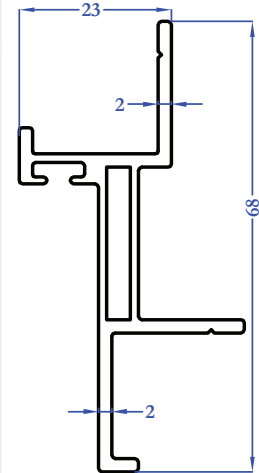

9276
0,681 kg/m

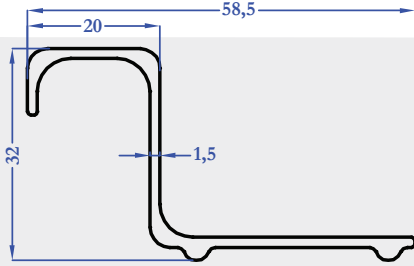

9272
0,451 kg/m

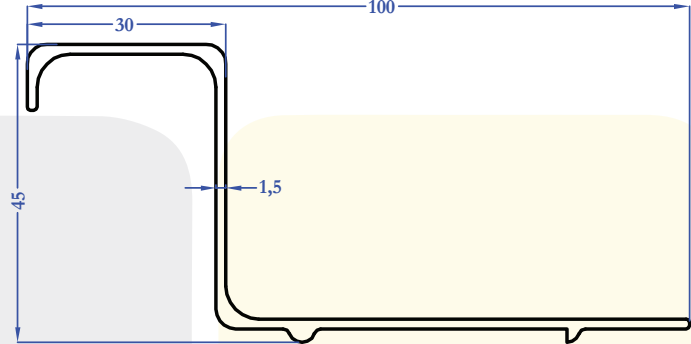

9273
0,664 kg/m

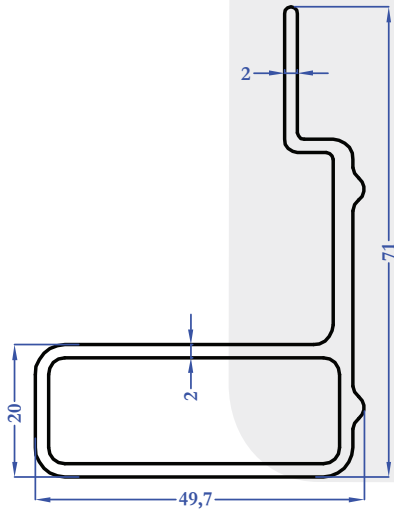

9301
1,101 kg/m

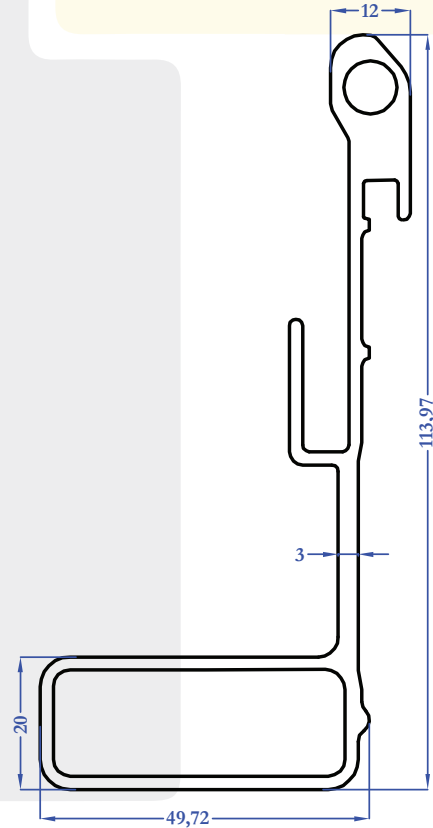

9302
1,805 kg/m

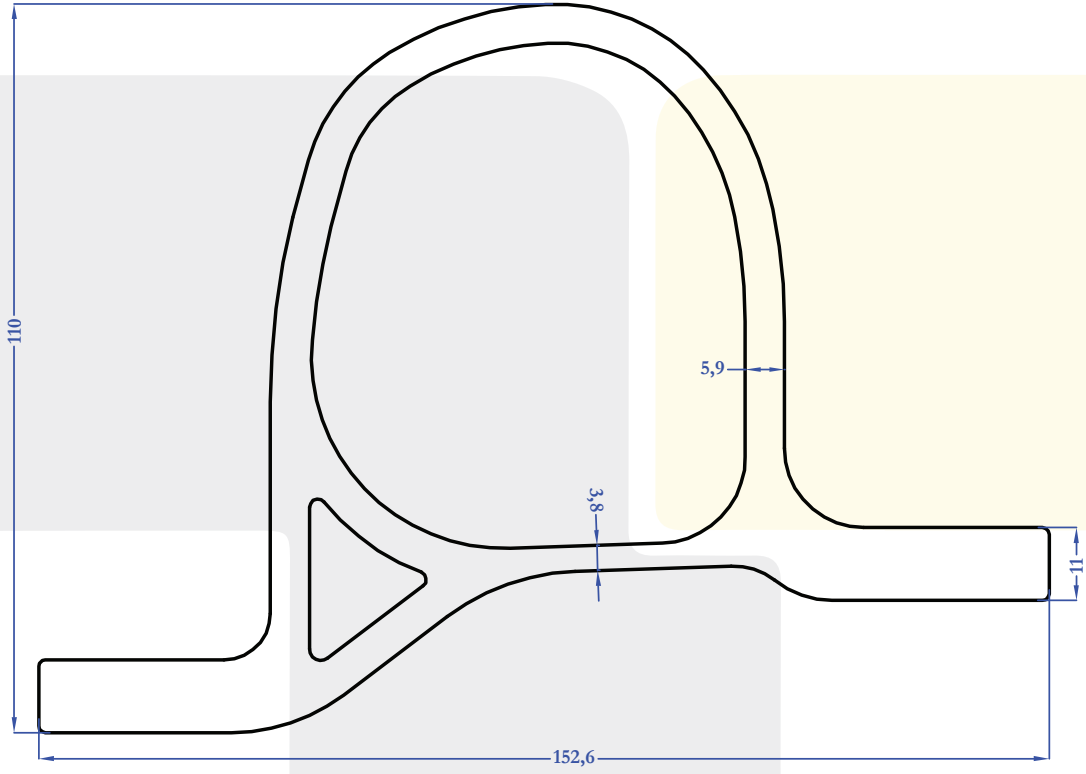

9316
7,538 kg/m

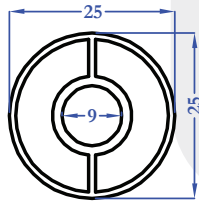

9309
0,369 kg/m

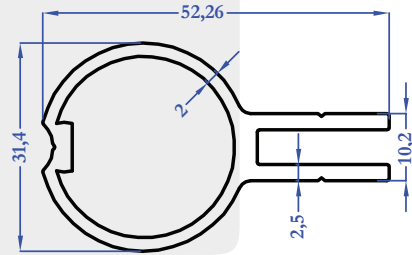

9308
0,844 kg/m

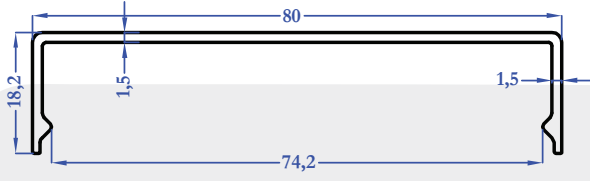

9324
0,468 kg/m

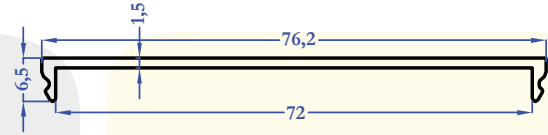

9325
0,348 kg/m

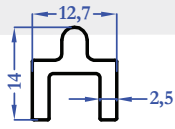

9337
0,212 kg/m

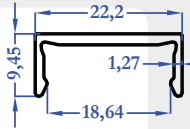

9354
0,152 kg/m

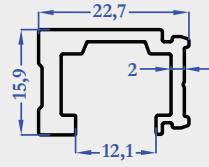

9355
0,356 kg/m

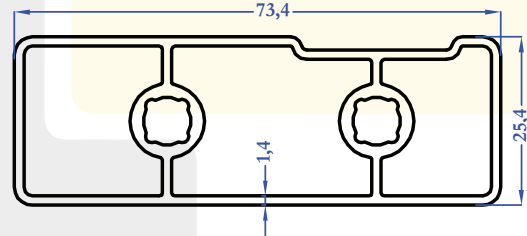

9357
1,101 kg/m

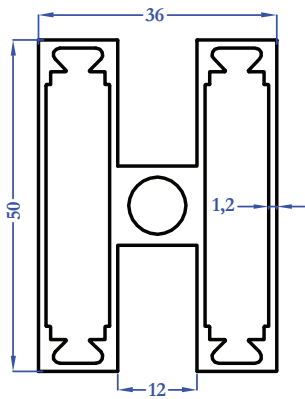

9342
1,176 kg/m

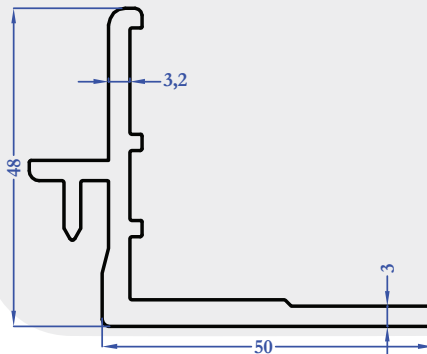

9343
1,067 kg/m

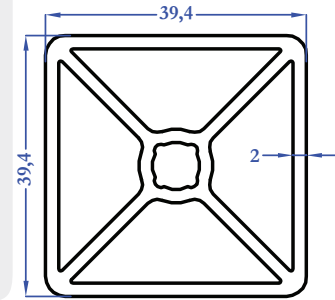

9356
1,357 kg/m

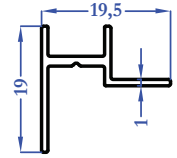
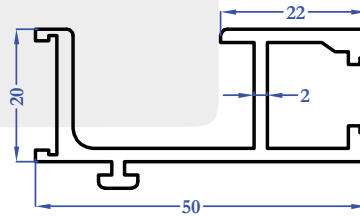
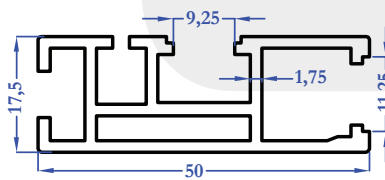
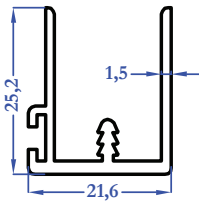
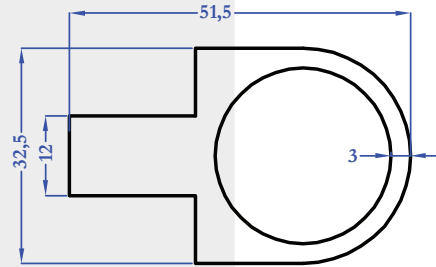
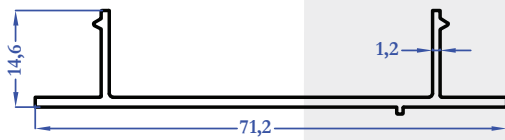
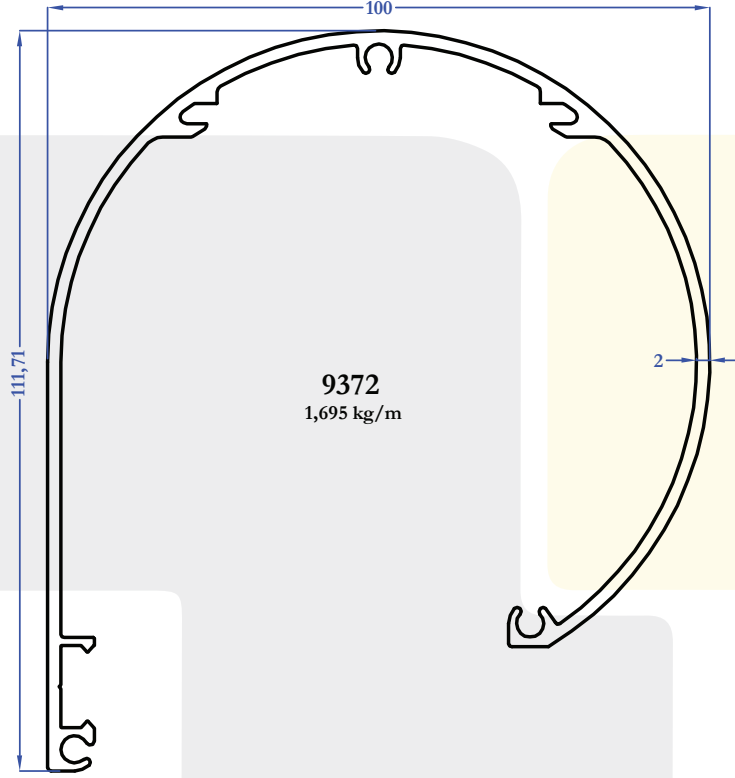

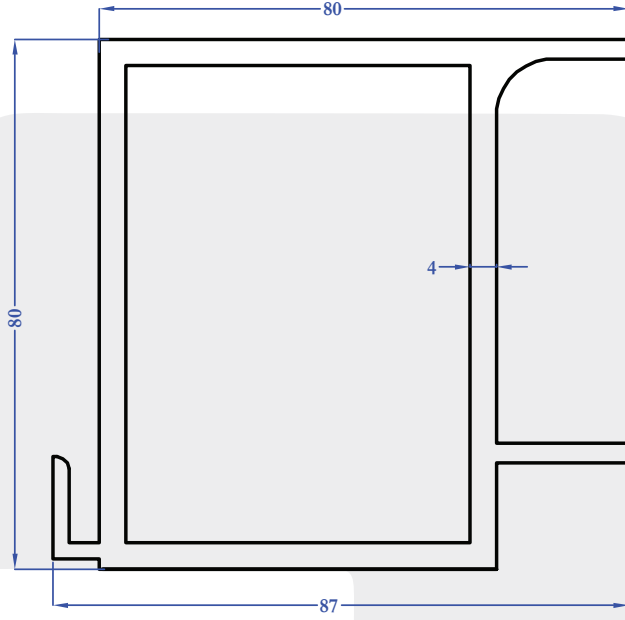

9384
3,360 kg/m

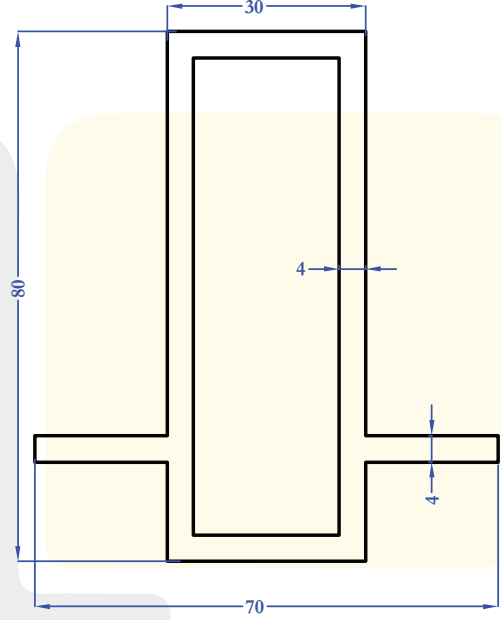

9385
2,644 kg/m

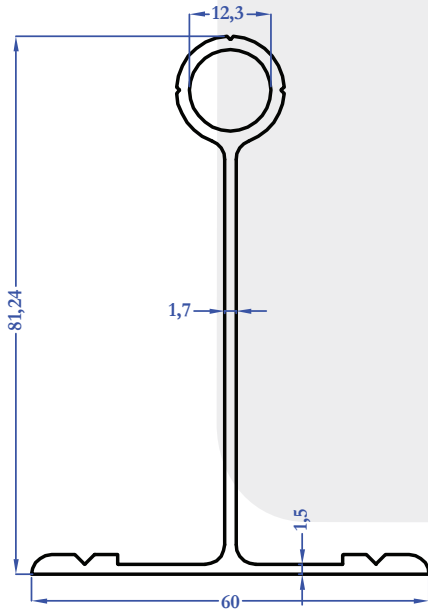

9386
0,878 kg/m

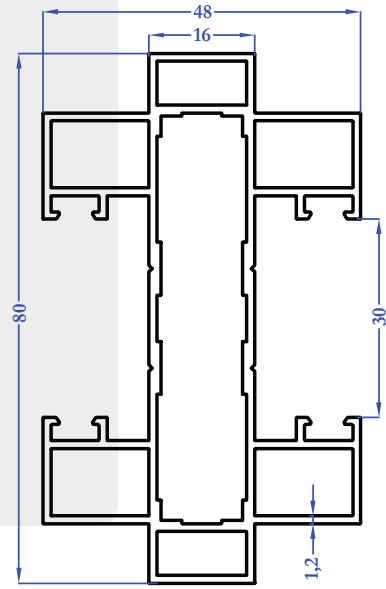

9387
1,447 kg/m

KATALOG DEĞERLERİ TEORİKTİR.

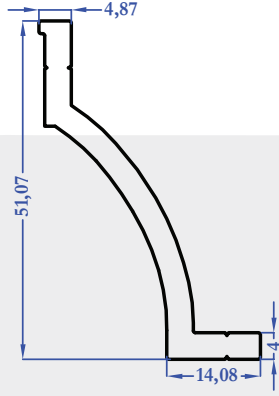

9412
0,161 kg/m

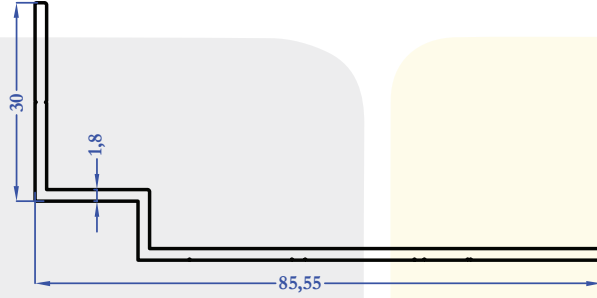

9413
0,600 kg/m

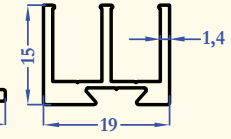

9414
0,260 kg/m

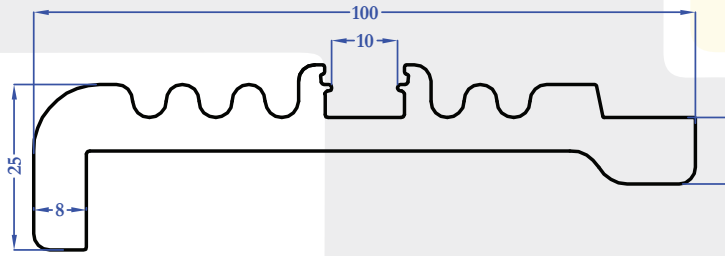

9422
2,531 kg/m

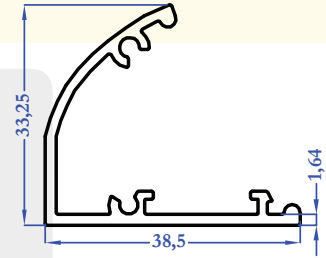

9430
0,429 kg/m

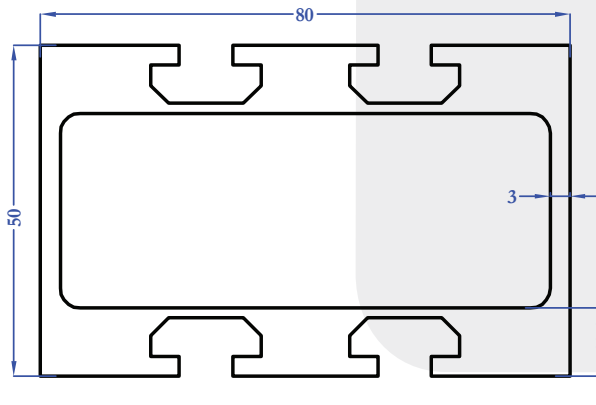

9426
3,737 kg/m

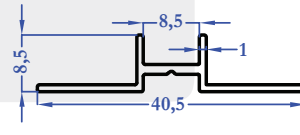

9393
0,161 kg/m

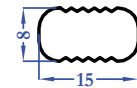

9431
2,531 kg/m

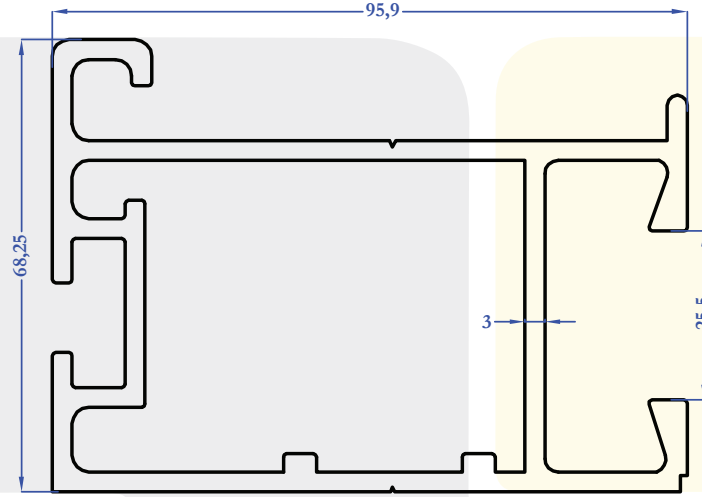

9450
3,266 kg/m

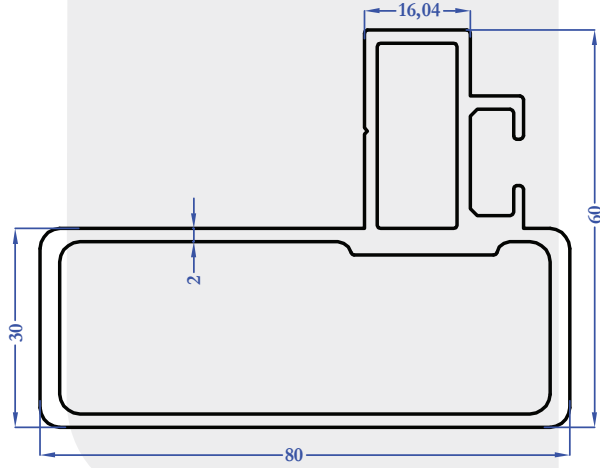

9464
1,932 kg/m

KATALOG DEĞERLERİ TEORİKTİR.

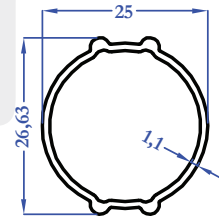
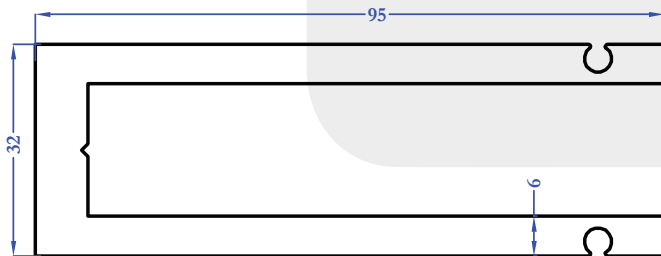
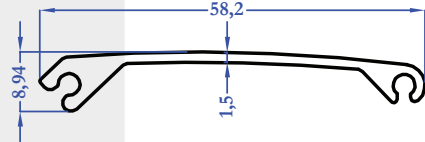
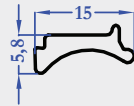
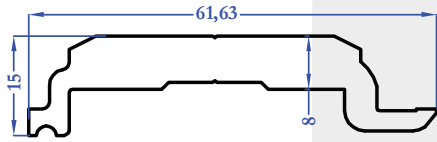
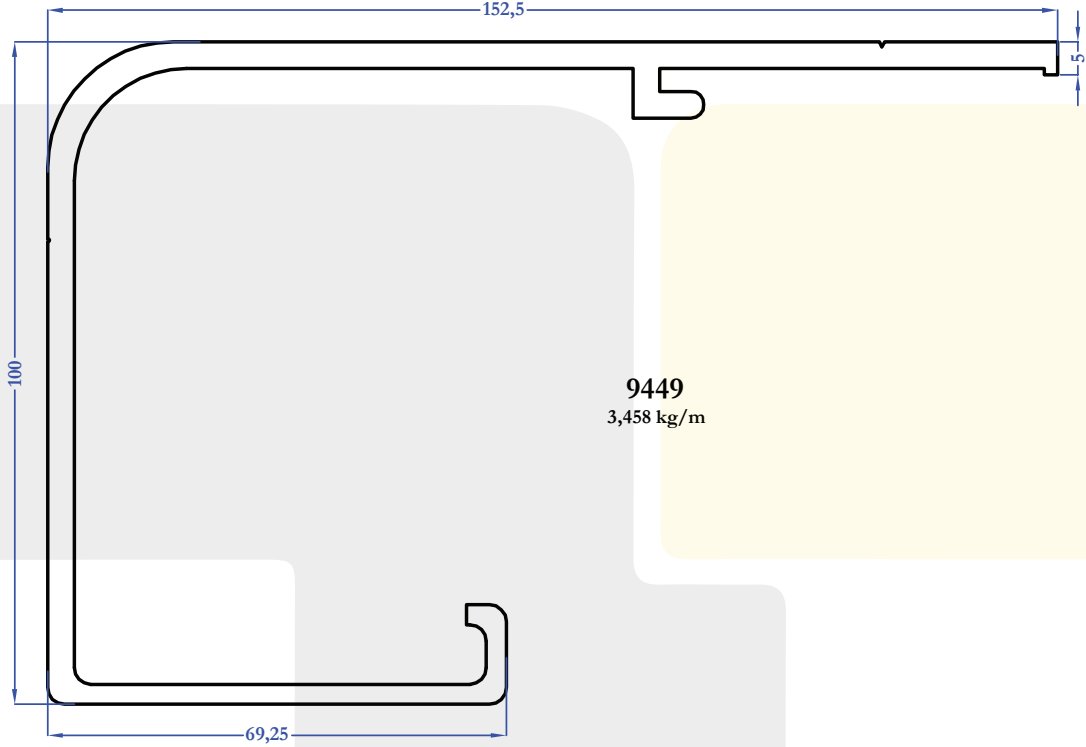

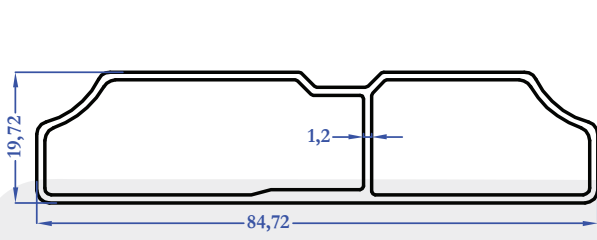

9474
0,720 kg/m

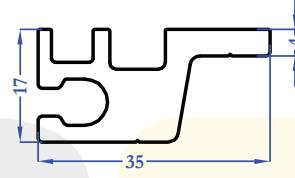

9468
0,778 kg/m

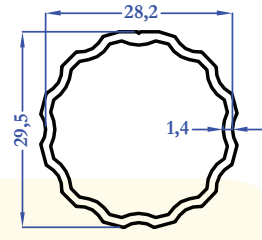

9475
0,357 kg/m

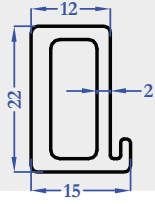

9476
0,404 kg/m

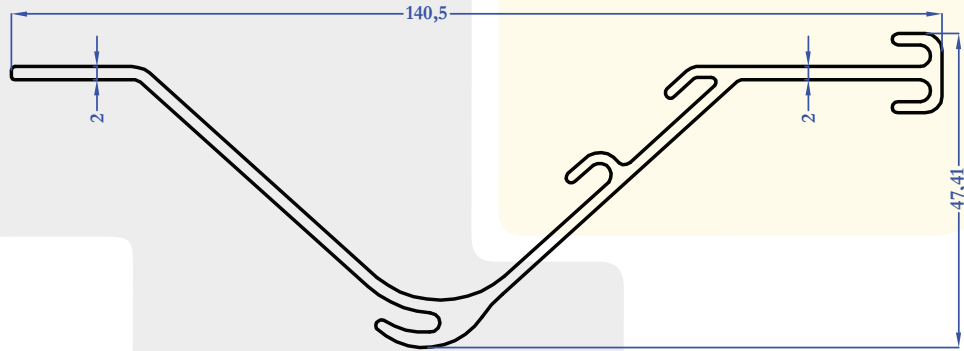

9496
1,192 kg/m

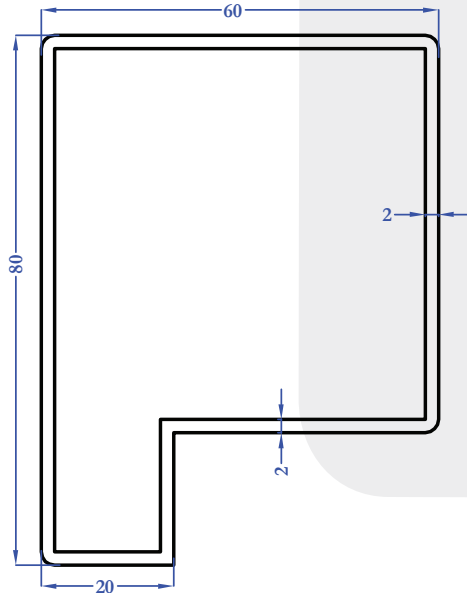

9504
1,463 kg/m

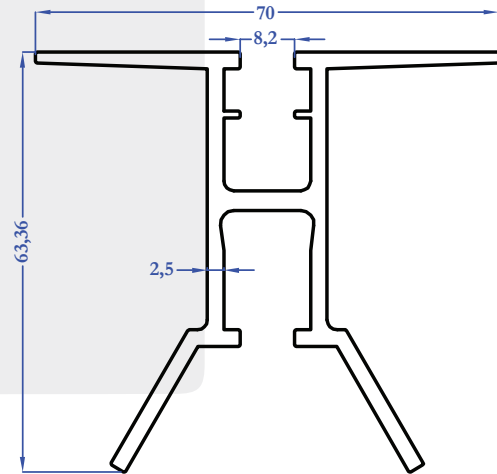

9527
1,411 kg/m

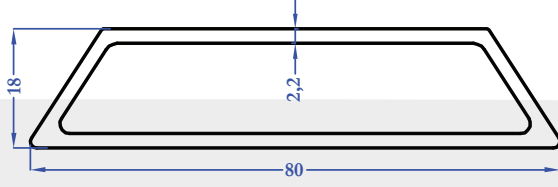

9530
1,035 kg/m

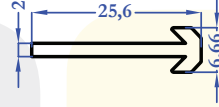

9531
0,178 kg/m

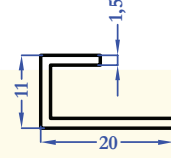

9557
0,150 kg/m

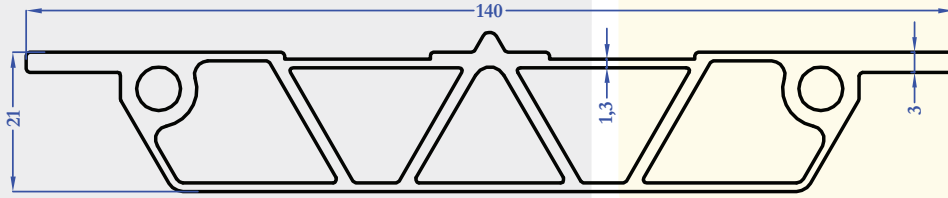

9540
1,941 kg/m

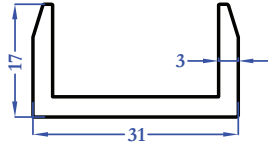

9561
0,459 kg/m

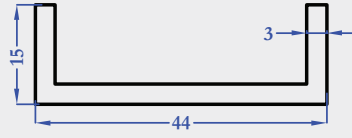

9565
0,553 kg/m

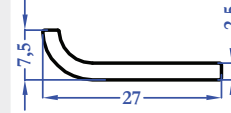

9567
0,198 kg/m

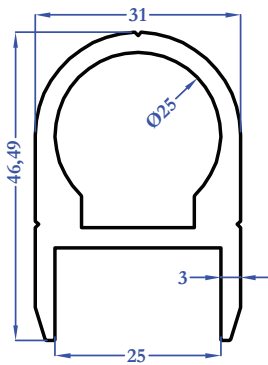

9562
1,208 kg/m

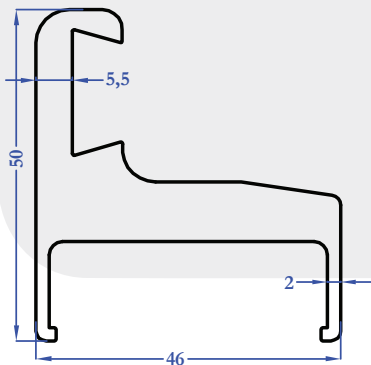

9566
1,817 kg/m

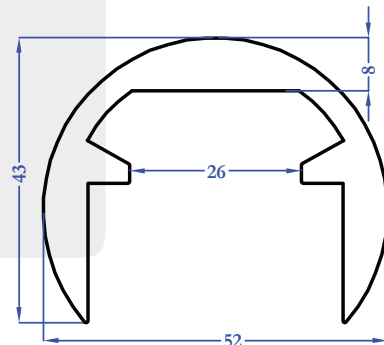

9568
1,708 kg/m

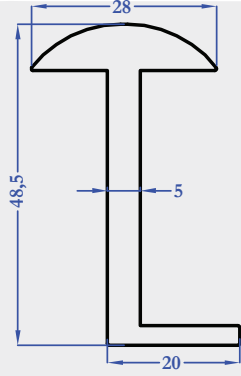

9569
1,068 kg/m

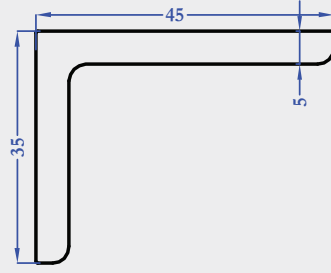

9570
1,012 kg/m

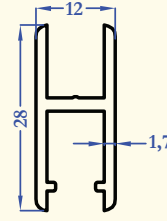

9571
0,306 kg/m

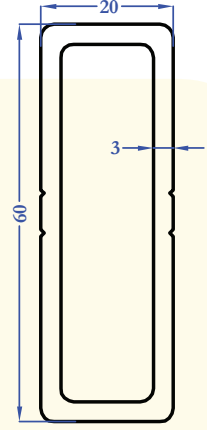

9578
1,201 kg/m

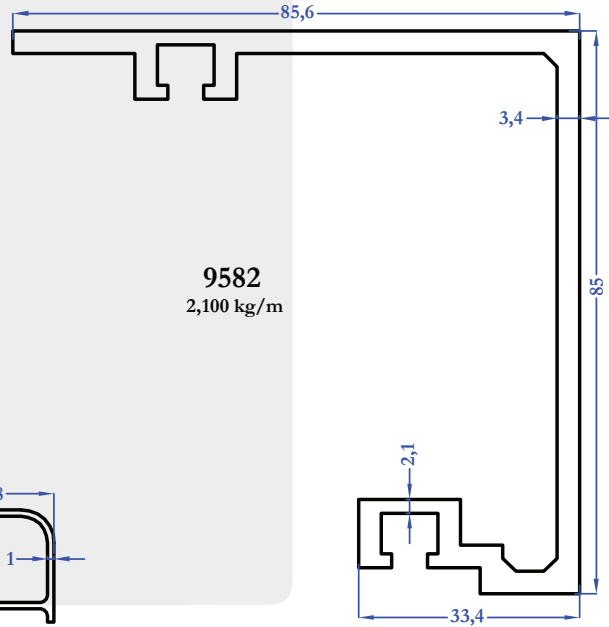

9582
2,100 kg/m

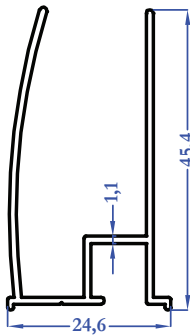

9592
0,372 kg/m

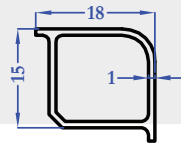

9579
0,163 kg/m

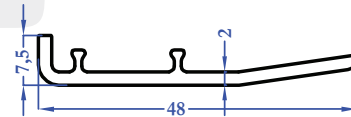
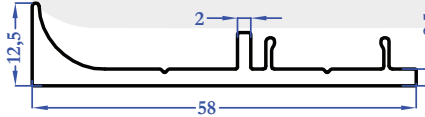
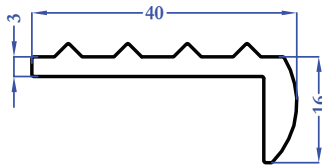
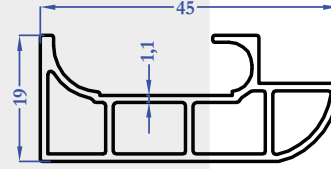
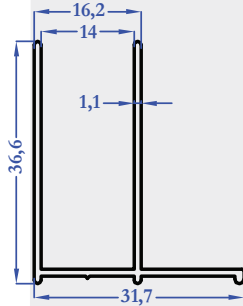
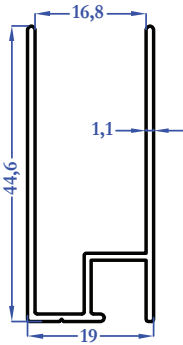
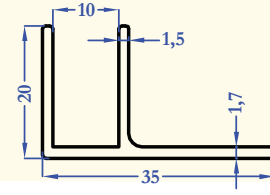
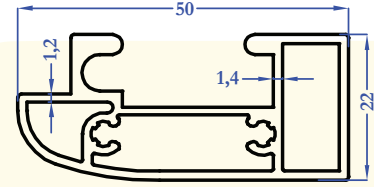
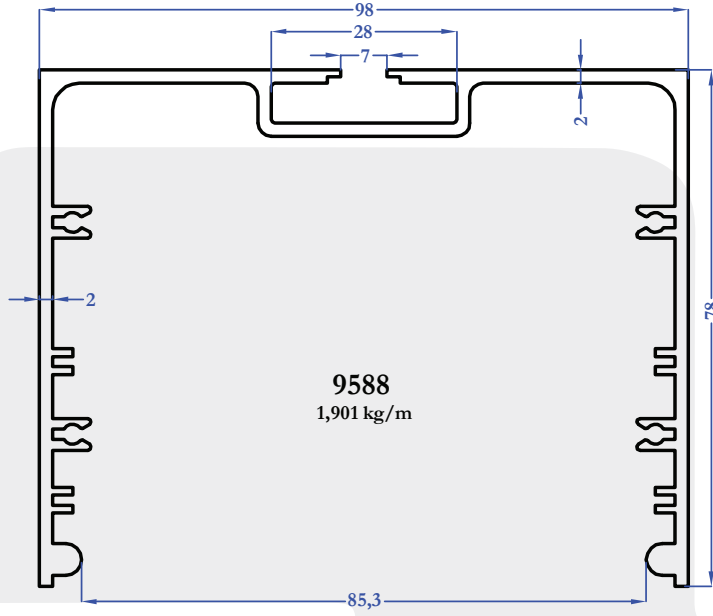

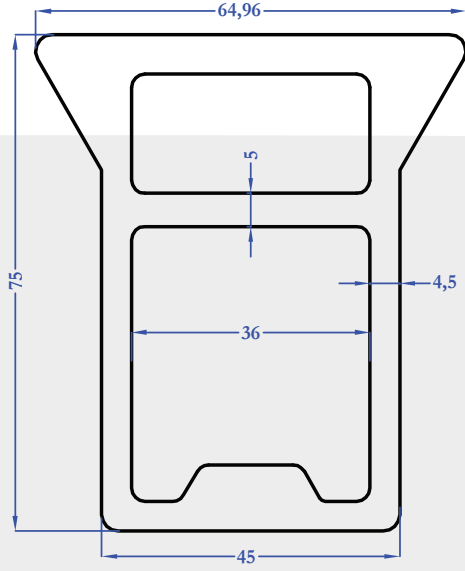

9609
4,257 kg/m

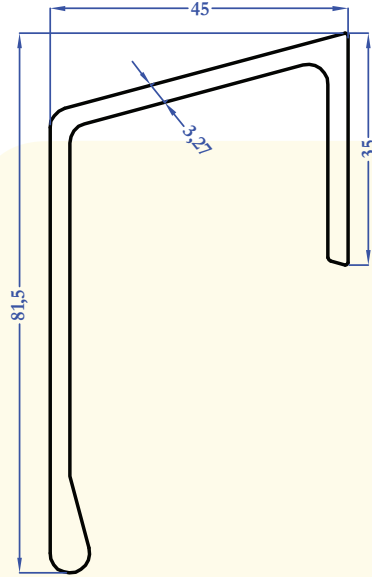

9616
1,248 kg/m

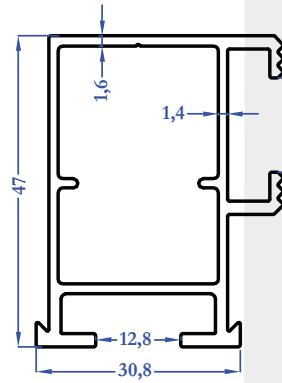

9615
0,814 kg/m

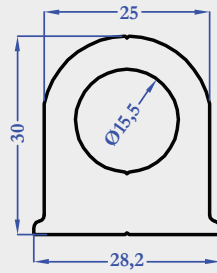

9614
1,364 kg/m

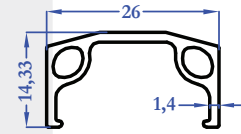

9619
0,238 kg/m

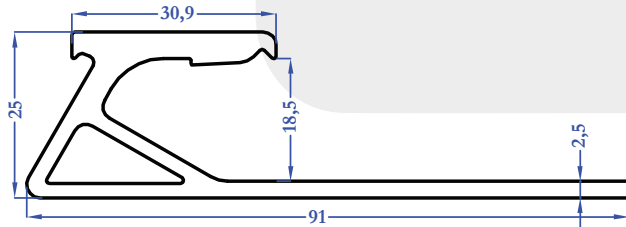

9617
1,262 kg/m

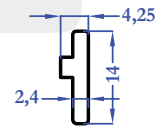

9621
0,105 kg/m

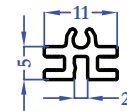

9623
0,112 kg/m

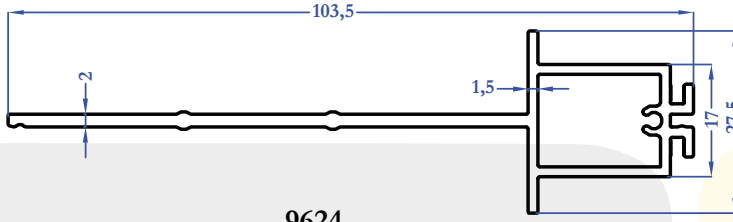

9624
0,827 kg/m

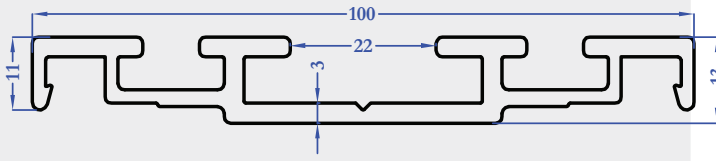

9640
1,313 kg/m

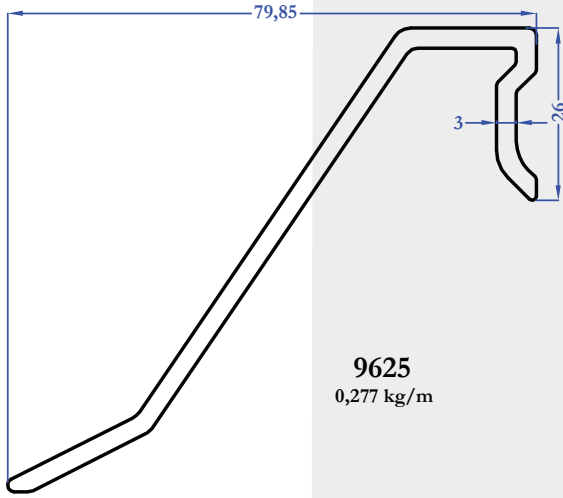

9625
0,277 kg/m

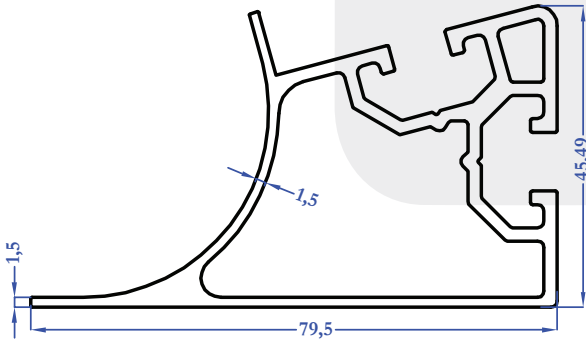

9642
1,426 kg/m

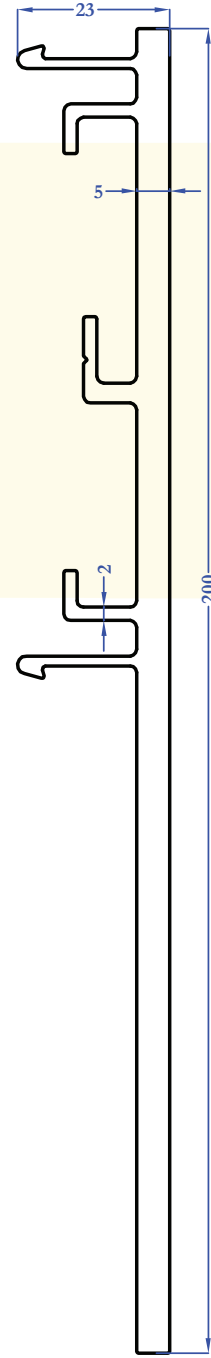

9641
3,185 kg/m

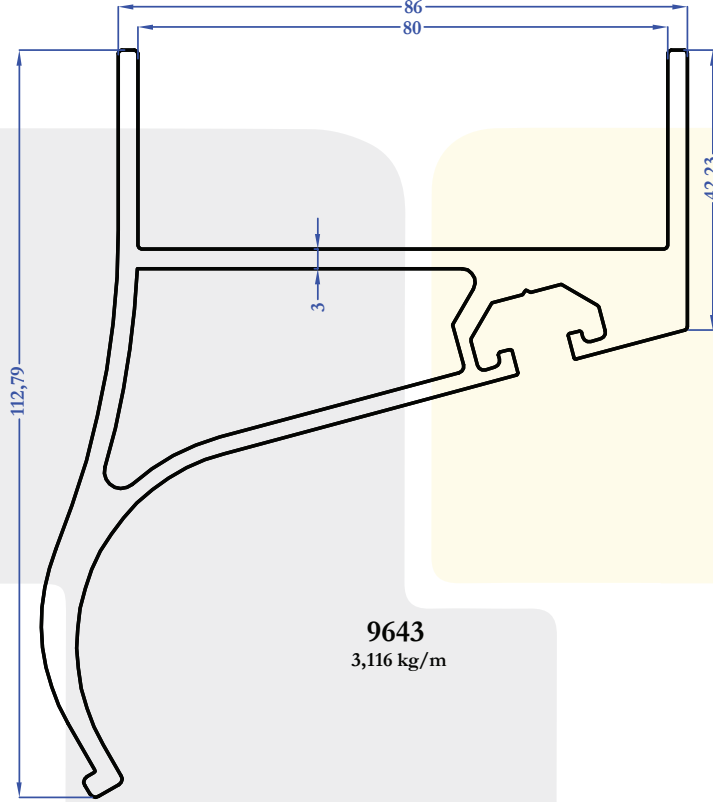

9643
3,116 kg/m

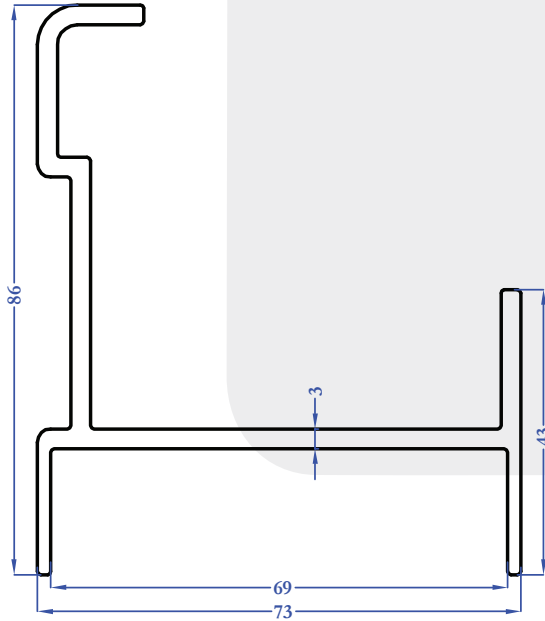

9646
1,616 kg/m

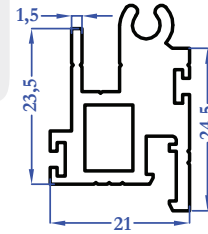

9644
0,749 kg/m

KATALOG DEĞERLERİ TEORİKTİR.

