

KATALOG DEĞERLERİ TEORİKTİR.

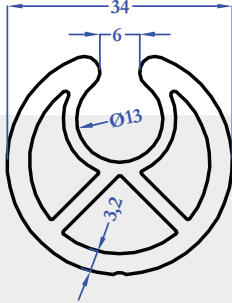

M5756
1,163 kg/m

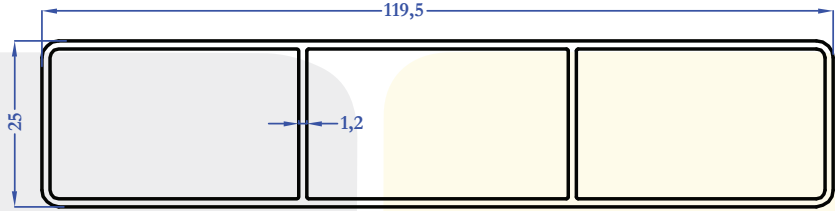

M5513
1,061 kg/m

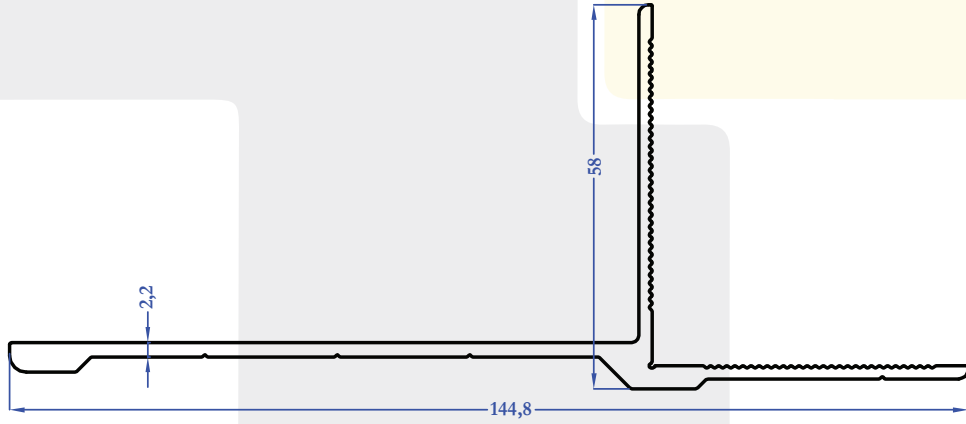

M5211
1,243 kg/m

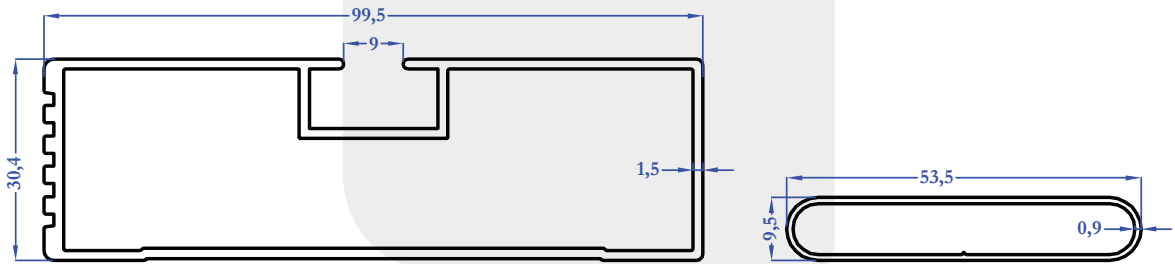

M5241
1,233 kg/m

E3932
0,281 kg/m

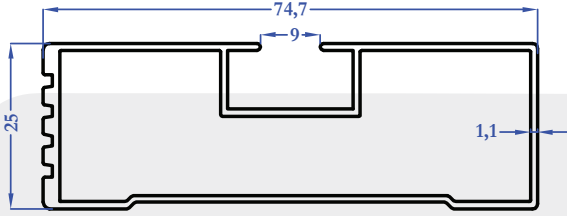

M5240
0,718 kg/m

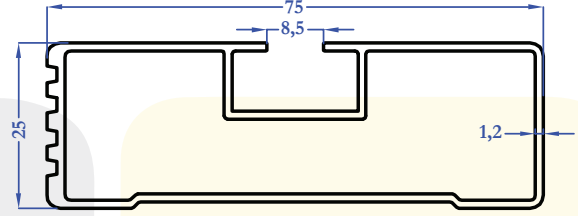

E2769
0,787 kg/m

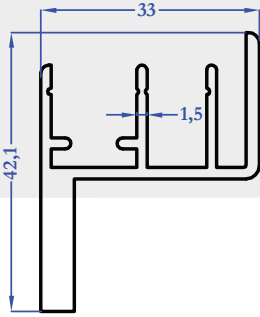

E2610
0,740 kg/m

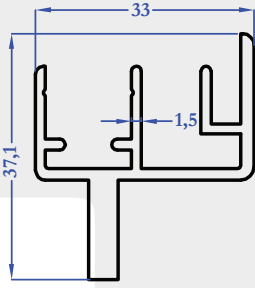

E2616
0,649 kg/m

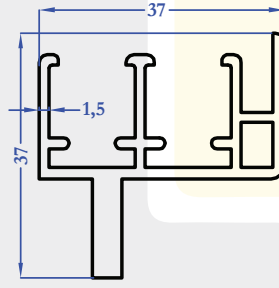

E1570
0,744 kg/m

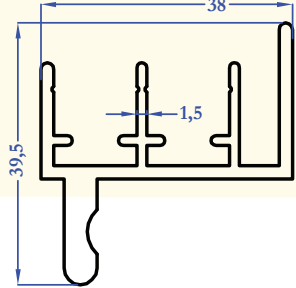

E1531
0,758 kg/m

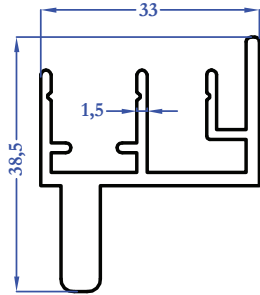

E1360
0,750 kg/m

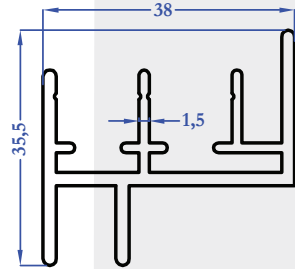

E1530
0,707 kg/m

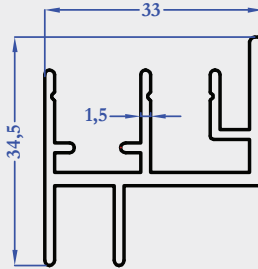

E1359
0,591 kg/m

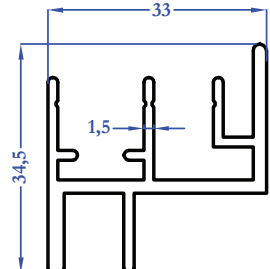

E1823
0,623 kg/m

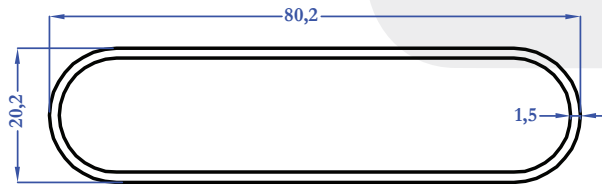

E2781
0,727 kg/m

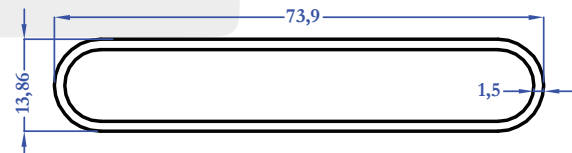

E2782
0,646 kg/m

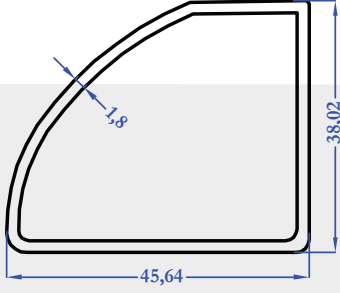

E1839-1
0,702 kg/m

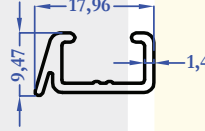

E1882
0,152 kg/m

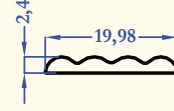

E1128
0,107 kg/m