

3215
1,514 kg/m

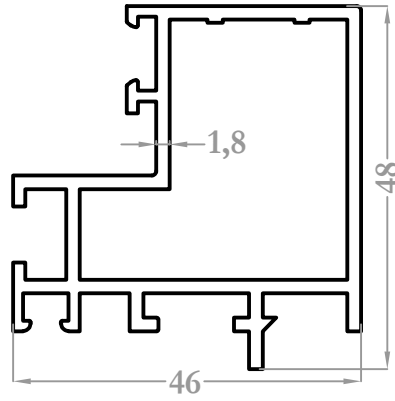

3501
1,020 kg/m

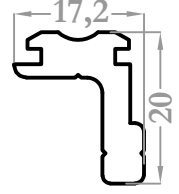

3505
0,370 kg/m

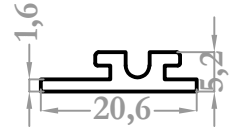

3504
0,152 kg/m

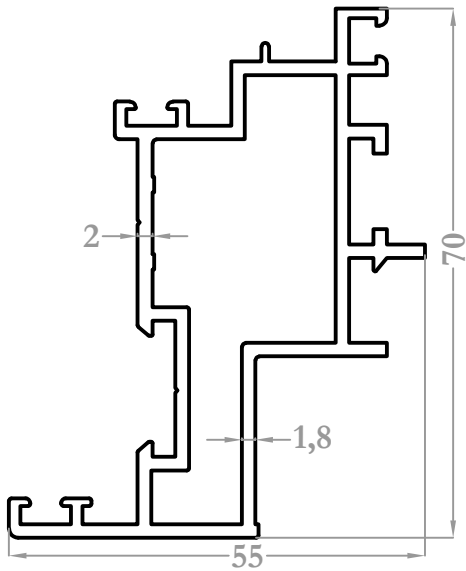

3502
1,305 kg/m

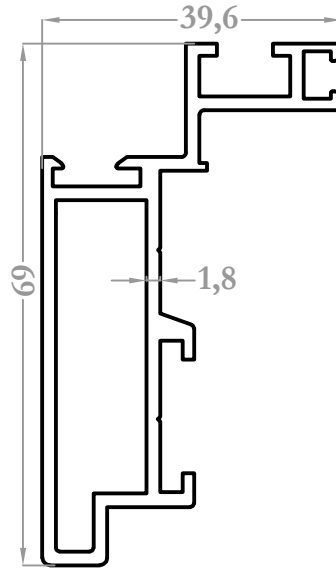

3503
1,005 kg/m

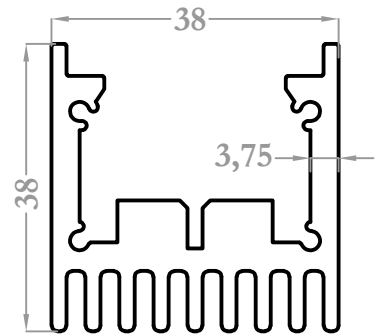

8767
1,580 kg/m

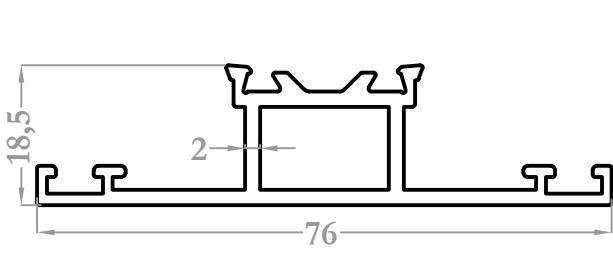

2602
0,791 kg/m

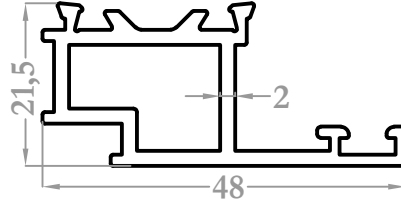

2603
0,661 kg/m

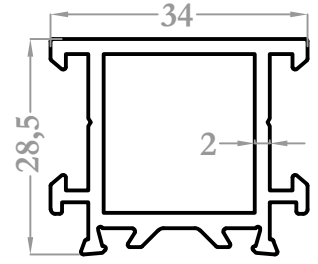

2590
0,702 kg/m

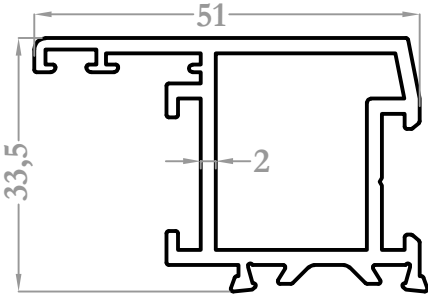

2604
0,921 kg/m

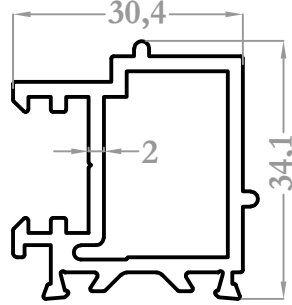

2623
0,776 kg/m

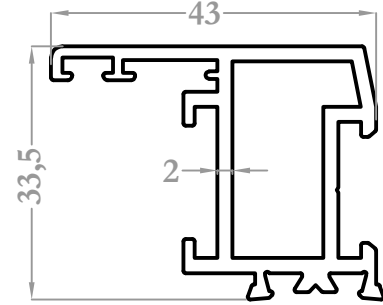

1946
0,818 kg/m

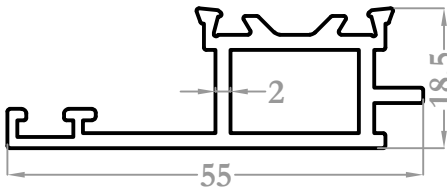

2605
0,658 kg/m

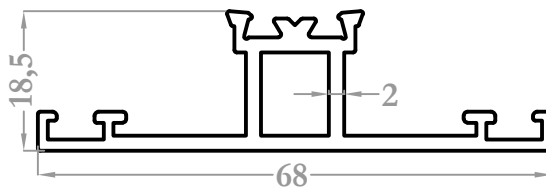

1945
0,697 kg/m

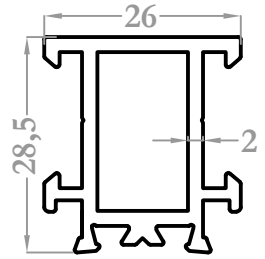

1944
0,610 kg/m

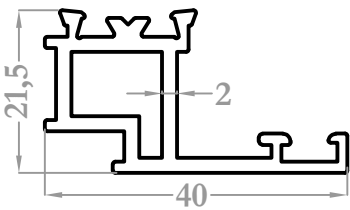

1947
0,566 kg/m

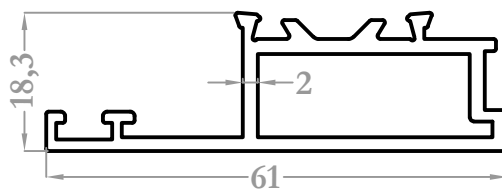

2624
0,696 kg/m

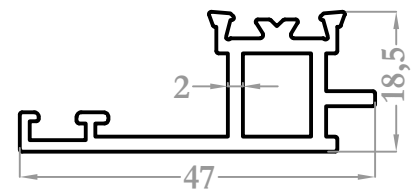

1943
0,563 kg/m

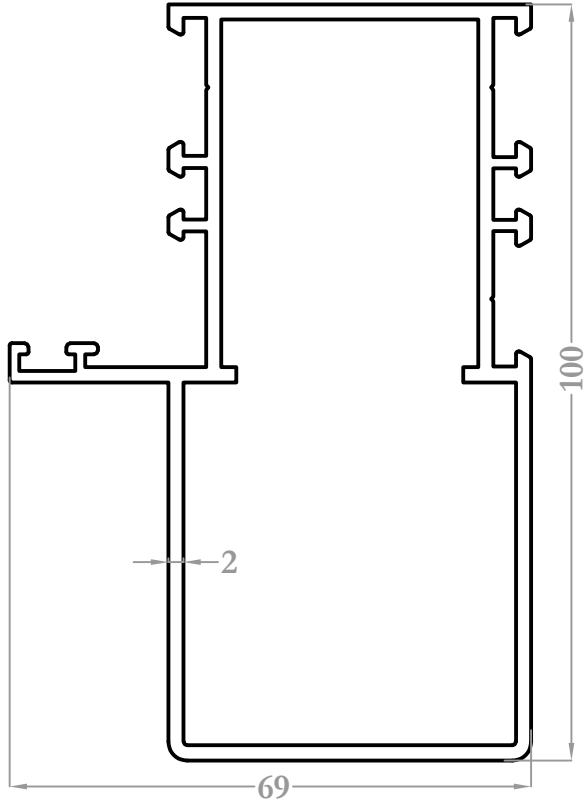

4531
1,929 kg/m

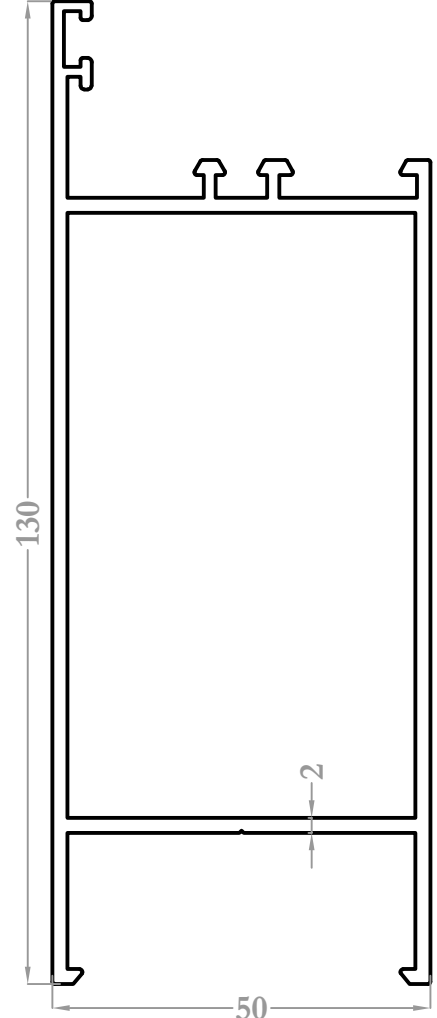

4533
1,910 kg/m

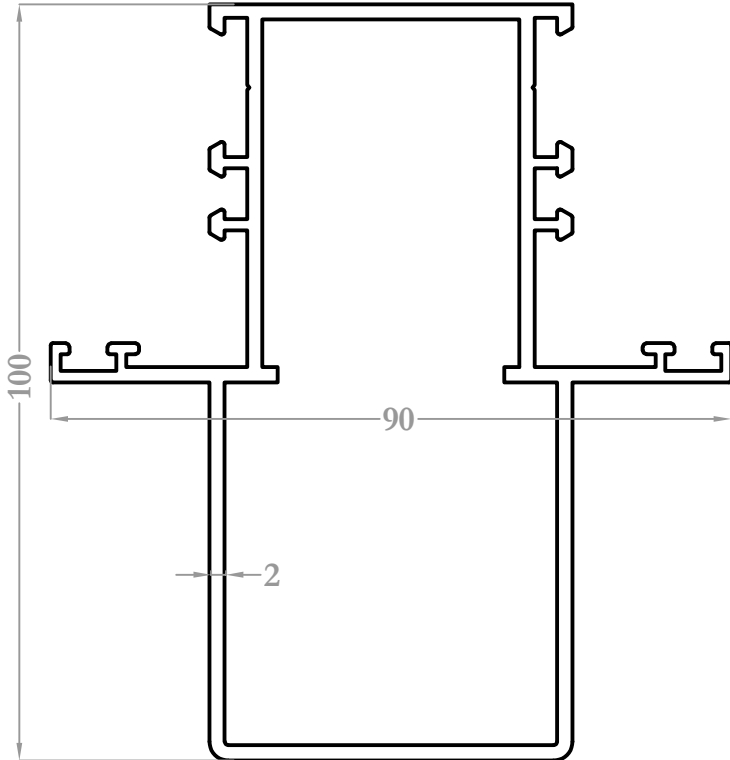

4532
2,054 kg/m

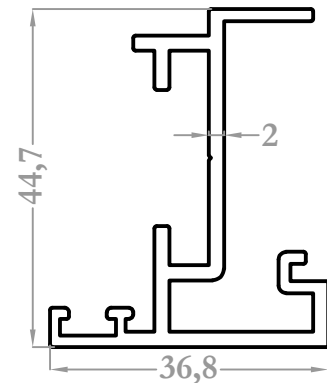

4536
0,735 kg/m

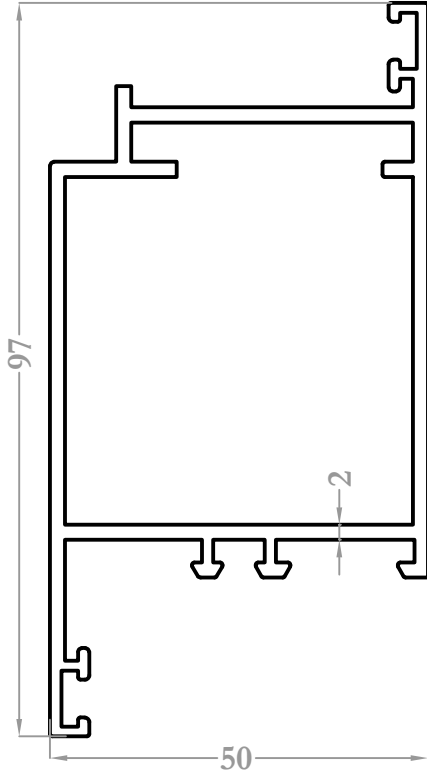

4534
1,558 kg/m

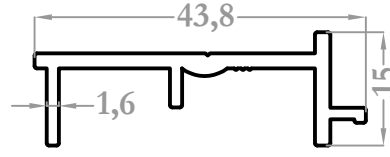

4535
0,380 kg/m

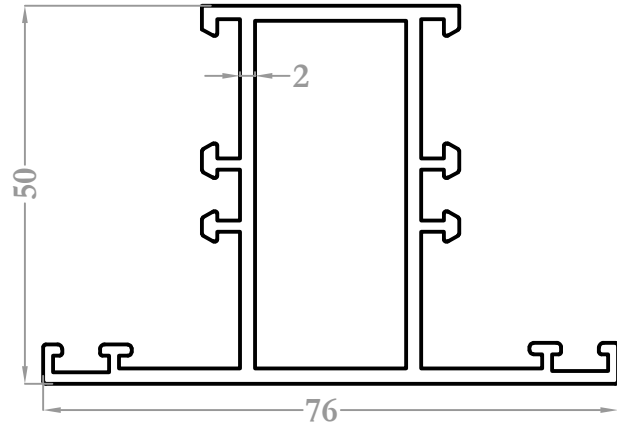

4538
1,300 kg/m

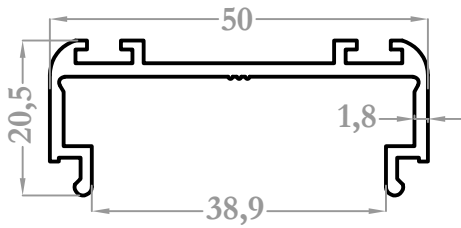

4666
0,501 kg/m

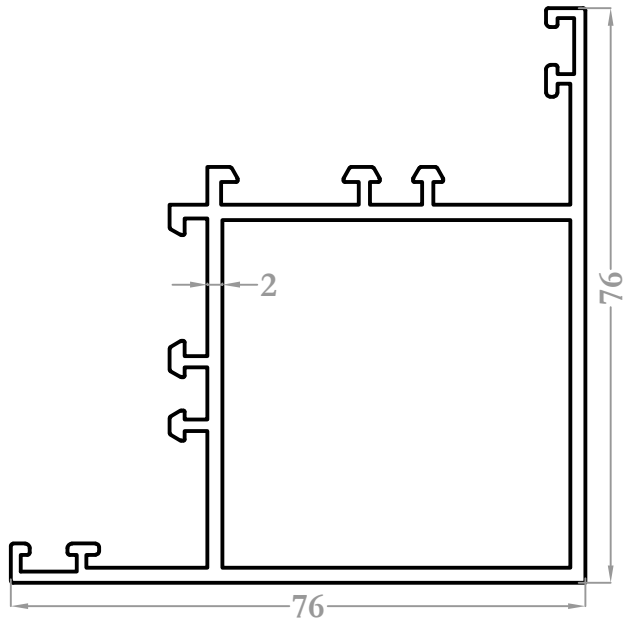

4539
1,582 kg/m

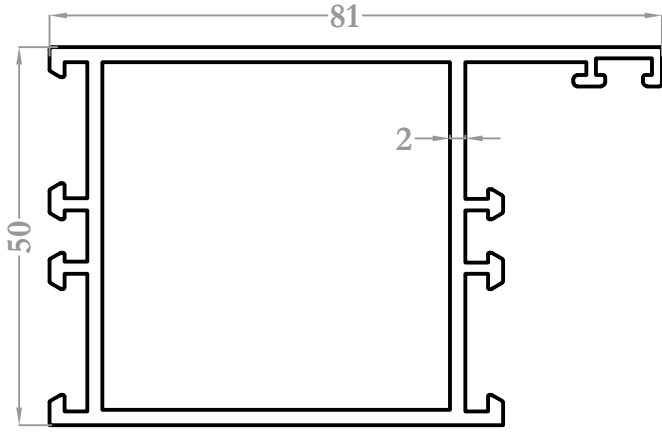

4667
1,450 kg/m

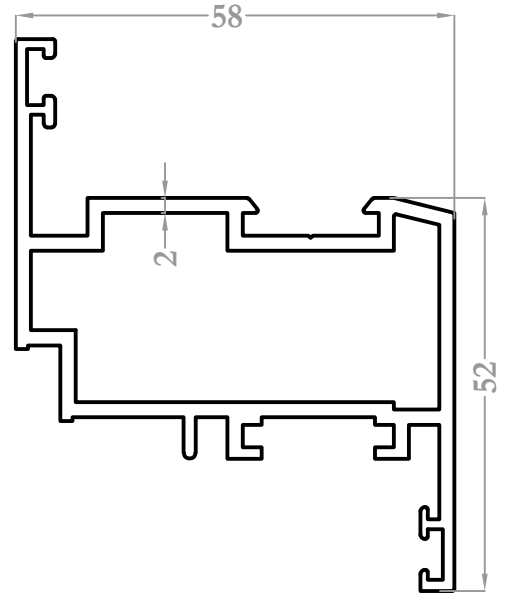

4680
1,390 kg/m

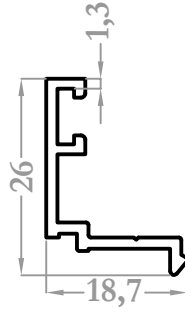

3013
0,211 kg/m

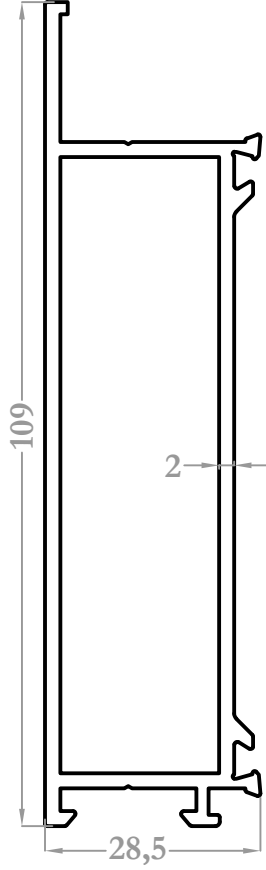

8700
1,401 kg/m

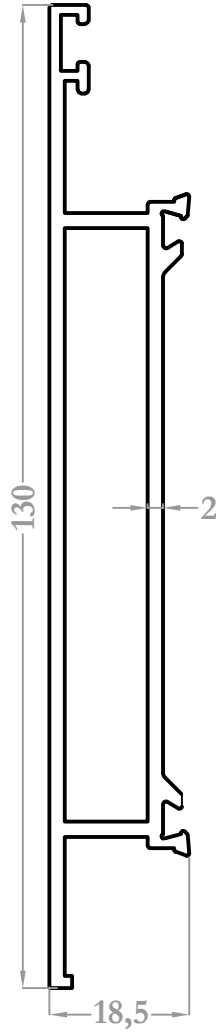

8701
1,393 kg/m

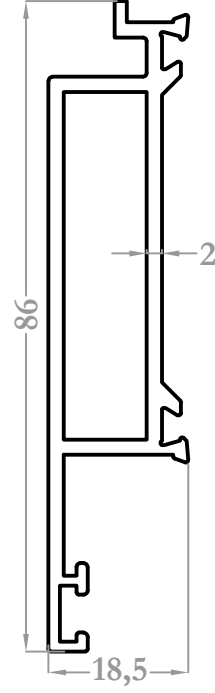

8717
0,978 kg/m

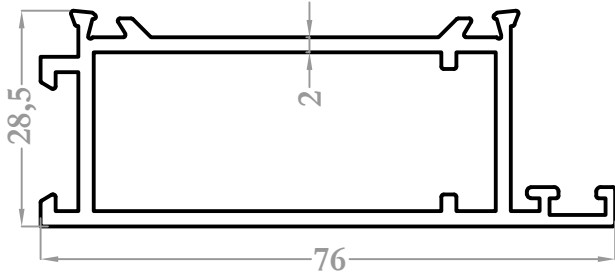

8718
1,120 kg/m

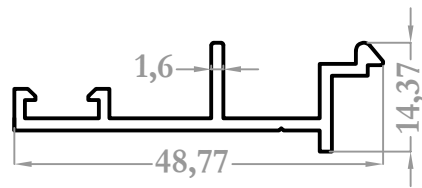

8735
0,346 kg/m

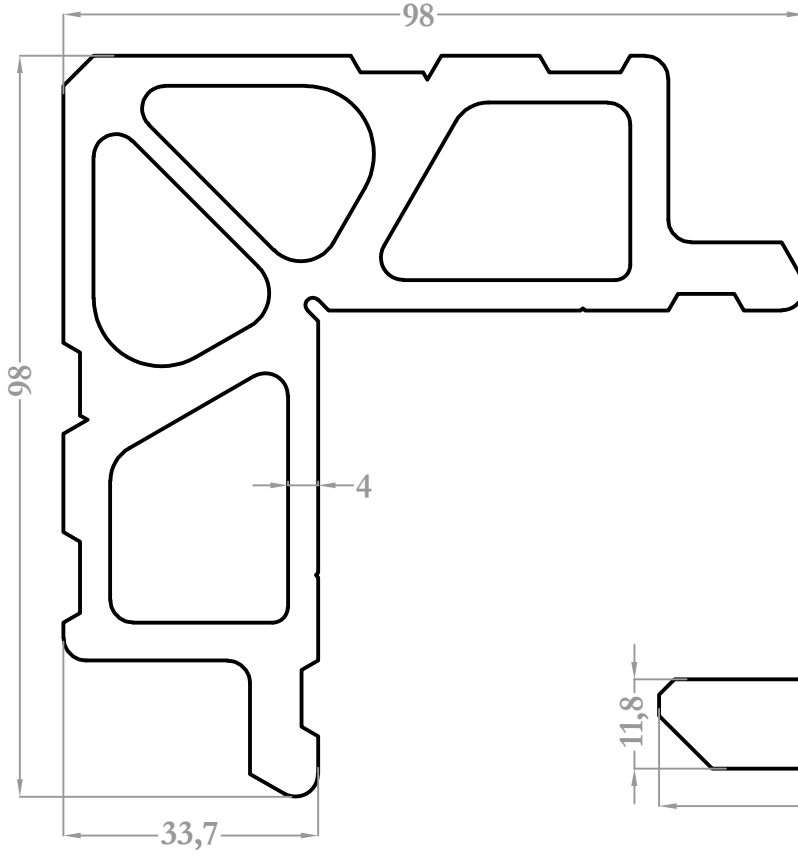

3054
5,840 kg/m

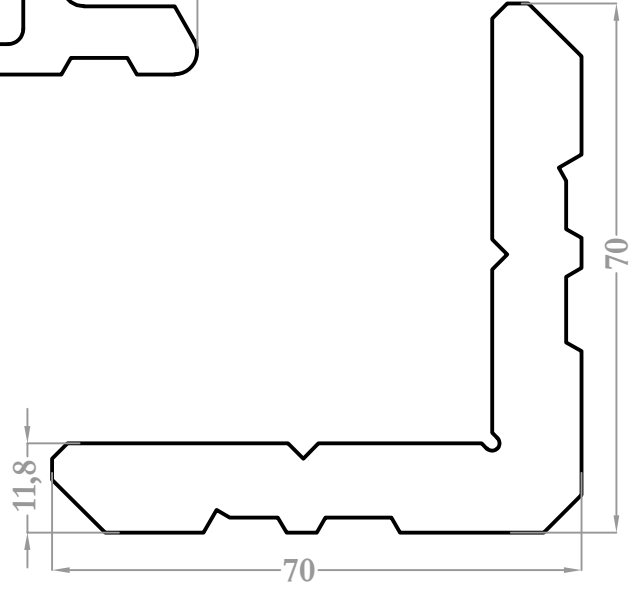

3036
3,672 kg/m

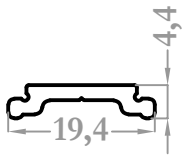

3028
0,128 kg/m

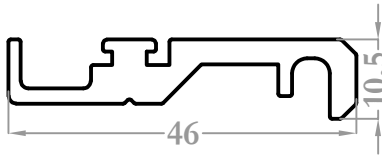

2599
0,597 kg/m

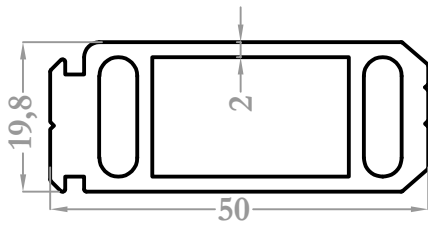

3027
0,211 kg/m

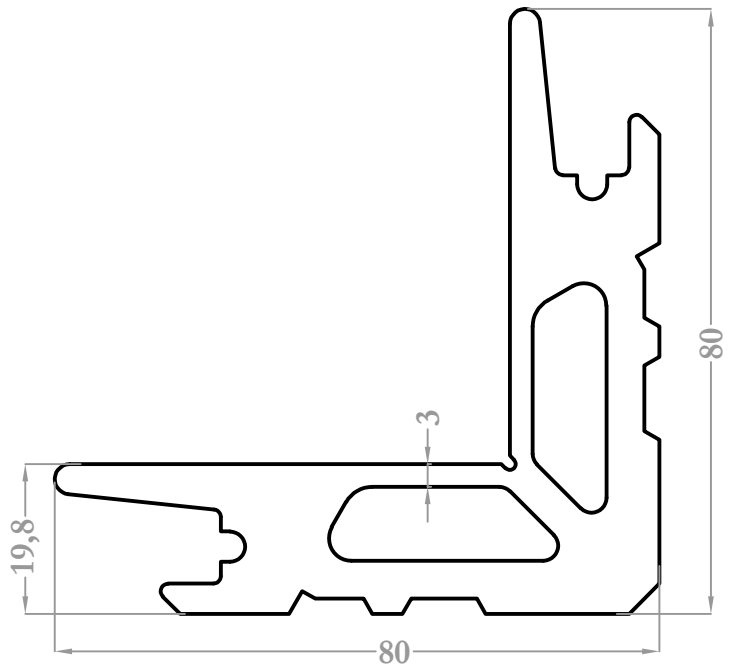

3052
4,186 kg/m