

**37085**  
0,247 kg/m

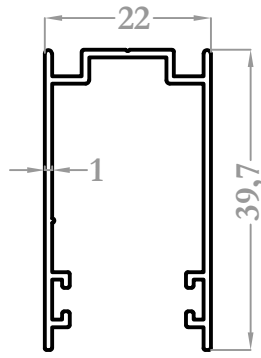

**8706**  
0,323 kg/m

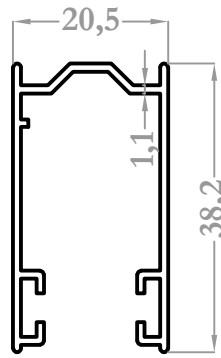

**37086**  
0,336 kg/m

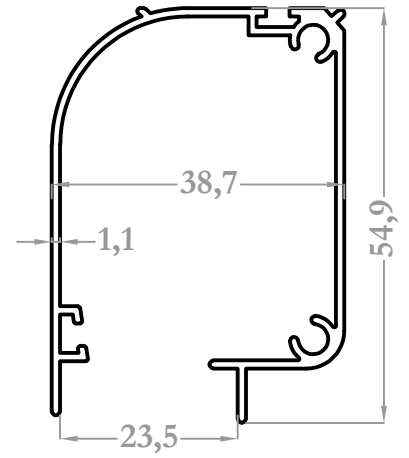

**8708**  
0,562 kg/m

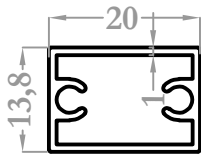

**37087**  
0,223 kg/m

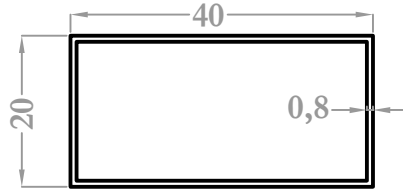

**886**  
0,252 kg/m

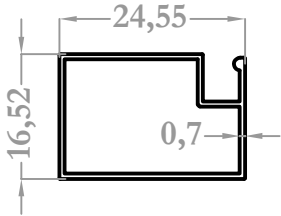

**37089**  
0,164 kg/m

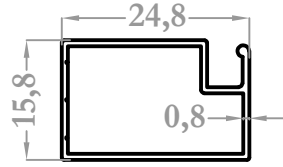

**37090**  
0,184 kg/m

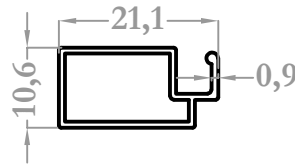

**37091**  
0,139 kg/m

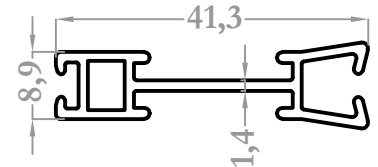

**8705**  
0,342 kg/m

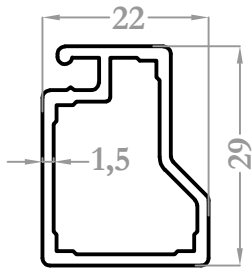

**1911**  
0,424 kg/m

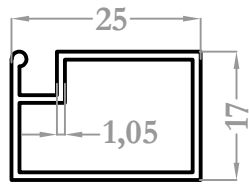

**1910**  
0,246 kg/m

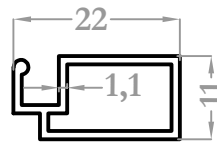

**1909**  
0,194 kg/m

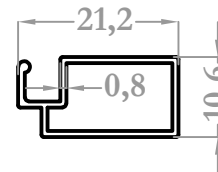

**1922**  
0,139 kg/m

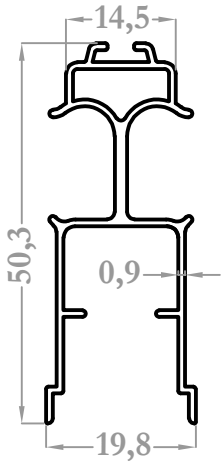

**37092**  
0,380 kg/m

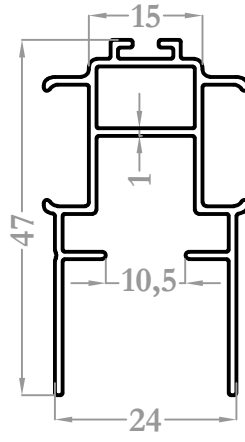

**37093**  
0,436 kg/m

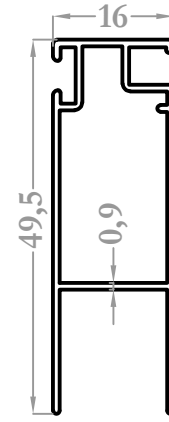

**37094**  
0,348 kg/m

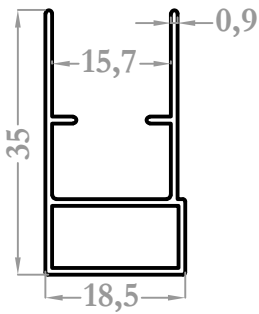

**37095**  
0,267 kg/m

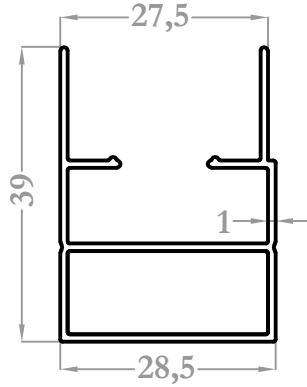

**37096**  
0,396 kg/m

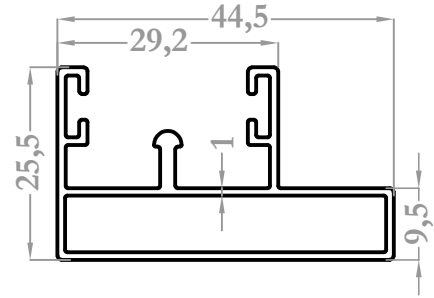

**37097**  
0,485 kg/m

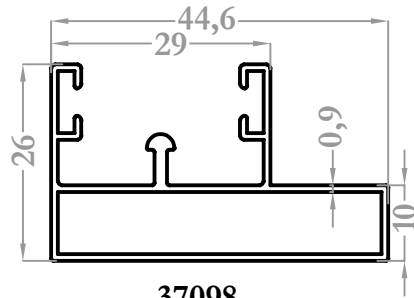

**37098**  
0,426 kg/m